

All Wide Range

# Programmable DC Power Supply

World First Wide Range Input and Wide Range Output



Solar Array Simulator

DSP-WS

DSP-WAs

DC Power Supply

DSP-WR

DSP-WE

DSP-WA

DSP-WAe

POWER  
- UP TO -  
**18kW**

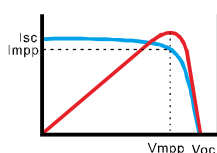
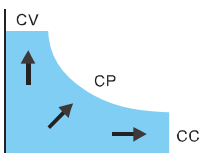

# Environmental Mission / iDRC and the Environment

We are devoting to product Innovation and development, also effort to environmental protection as social responsibility. While enhancement of our products, the influence of our products to the environment throughout their life cycles has been concerned and controlled by our environmental management that we focus on reducing the impact from product design, material use, manufacturing, packaging, transportation, product use, and recycling.

## ● Purpose of Design

Our purpose of designing and producing the products is to allow every customer to have more efficient use of energy and be able to obtain power in an environmentally friendly way. Furthermore, our products are aimed to help our customers understand the energy operation better in order to precisely develop and design remarkable energy applied products.

Our products include DC power supply, AC power source and Power analyzer. They are mainly used in Wind, Solar and other green power energy research and development laboratories, all kinds of electric vehicles, home appliances and IT products R & D and production. We aim to help these environmentally friendly energies to be well accepted and all of our customers are able to design/develop low consumption products that not only meet the standard but also help to reduce gas emission.



## ● Eliminating Toxic Materials/Substances

We are very strict in selecting materials/substances that we do not use any harmful/toxic substances neither in our products nor packaging. All of our products and packaging strictly follow the rules of RoHS Directive, WEEE and other environmental laws/regulations. We do not only forbidden using harmful toxins, but also seek to exclude the possibility of use of harmful materials in our products.

## ● High Efficiency

From the perspective of high efficiency, we use low consumption equipments (i.e., information equipments that meet EAP energy efficiency requirements) for design. Meanwhile, we also select low-power components and apply the latest technology to reduce energy conversion losses. Applying Active Power Factor Correct (APFC) into the products makes the PF of the products higher than 0.95, which helps to improve the electricity quality of each product and reduce 20%~50% or more of energy waste.

We use the power regeneration load when testing/manufacturing which can reduce the energy consumption.

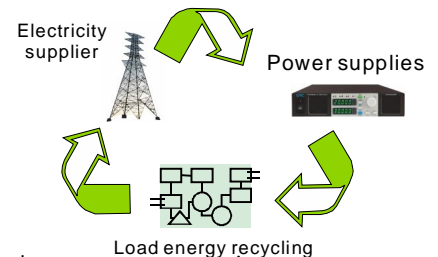

## ● Smaller Volume, Less energy waste

Designing small, compact, efficient product is another main goal of iDRC. This way can help to use less materials of packaging, and also enhance the efficiency of transportation. Hence, CO2 emission produced during transportation (from vehicles and ships) can be efficiently reduced.



## ● Life

Using high quality components and applying completed protection function into our product makes the life cycle of our products is either much longer or the failure rate is lower than the competitors. It is efficient to reduce CO2 emission and waste produced during transportation, maintenance, and obsolescence.



## ● Recycle

The recyclability of our products is higher than 85%. It means the impact of non-recyclable components to the environments will be reduced.

## Innovation

After decades of research and development, iDRC has obtained 224 patents by August 2019 including more than 37 invention patents.

The DSP-Wx series is benefit from 113 patents such as “HOME/BACK” multifunction key, Output-switch control system, Synchronization circuitry ... Making DSP-Wx series in leading position of the world.



## DSP-WR Patents

(Total 116 patents including 18 invention patents)

China	ZL 2014 3 0490203.4, ZL 2014 3 0490204.9, ZL 2015 2 0136770.9, ZL 2015 2 0229375.5 ZL 2014 2 0064432.4, ZL 2014 2 0539916.X, ZL 2015 2 0150534.2, ZL 2015 2 0573475.X ZL 2015 2 0573543.2, ZL 2015 3 0435062.0, ZL 2014 3 0130259.9, ZL 2015 3 0432790.6 ZL 2016 3 0005985.7, ZL 2016 3 0060739.1, ZL 2016 2 0154125.4, ZL 2016 2 0358539.9 ZL 2016 2 0353605.3, ZL 2016 2 0639352.6, ZL 2016 3 0135663.4, ZL 2017 3 0134857.7 ZL 2017 3 0601155.5, ZL 2017 3 0659600.3, ZL 2018 2 0461773.3, ZL 2018 3 0693371.1 ZL 2018 2 0801460.8
Germany	Nr 10 2015 002 824.3, Nr 20 2016 101 440.9, Nr 20 2016 102 507, Nr 20 2016 102 535, Nr 20 2013 011 929.2, Nr 20 2014 100 958.2, Nr 20 2015 103 504, Nr 20 2015 105 008, Nr 20 2015 105 009, Nr 20 2014 104 818.9, Nr 20 2015 102 036, Nr 20 2015 103 503, Nr 20 2016 103 687, Nr 20 2018 003 769, Nr 20 2019 001 474, Nr 20 2019 001 672, Nr 20 2018 001 645, Nr 20 2018 001 864
European Union	002468934-0001, 002597591-0001, 002597617-0001, 002844431-0001, 002847640-0001, 002941997-0001, 003004233-0001, 003076587-0001, 003935154-0001, 004508851-0001, 004561694-0001, 005831799-0001, 005616596-0001
Japan	3215943, 3220684, 3220912, 3221909
Taiwan	D170155, D172385, D172386, D174708, D186590, D177237, D177781, D180503, D184678, D187992, D191439, I472141, I530981, I610507, M512157, M486210, M490169, M500915, M504972, M505753, M512253, M520767, M524947, M524948, M524949, M560044, D197453, M566456, M569109, M577968
United States	US D771577, US D770396, US 9,513,500 B2, US 9,748,055, US 9,621,066 B2, US 9,287,769 B1, US 9,489,011 B2, US 9,240,730 B2, US 9,681,564 B2, US 9,538,679 B1, US D779,837 S, US D735,149S, US D782,424 S, US D785,710 S, US D785,711 S, US 9,787,189, US 9,801,292, US 9,674,973 B1, US 9,632,548 B1, US D782,417 S, US D815,608, US10,063,038 B1, US D848,945 S, US 10,264,709 B1

## Guarantee

iDRC commit to deliver the highest quality products. A great deal of high-precision instruments have been employed during development and production.

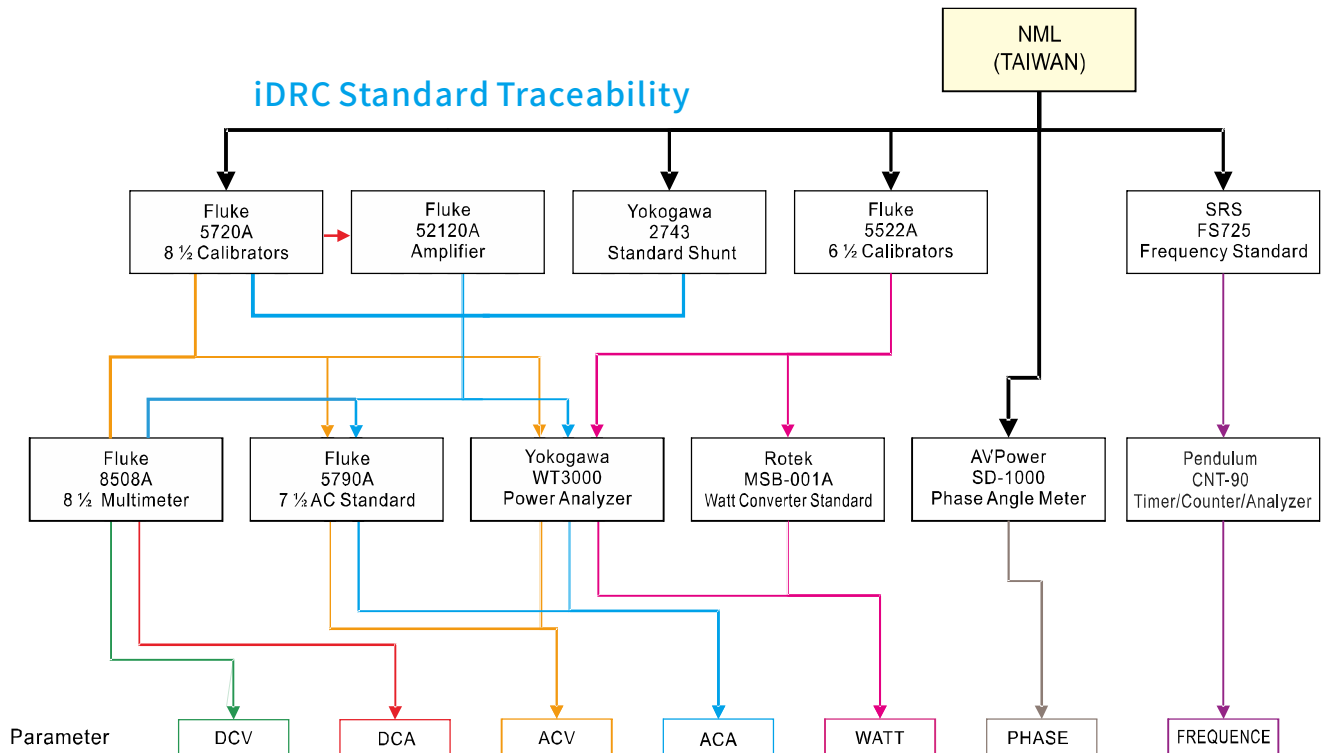

## Calibration Equipment

FLUKE (5720A, 5700A, 5522A, 5520A, 5500A, 52120A, 5790A, 8508A) 、 HP 3458A 、 Guildline 7620 、 SRS (FS725, SR620) 、 Pendulum CNT-90 、 Yokogawa (WT3000, 2743 [2A, 5A, 10A, 20A, 50A, 100A]) 、 Danisense Fluxgate DCCT (600A, 700A, 2000A) 、 LEM Ultrastab DCCT (60A, 150A, 600A, 700A, 1000A, 5000A) 、 ROTEK MSB-001A 、 AVPower SD-1000 ...etc.

## Development Instrumentation

Keysight/Agilent/HP (PA2201A, PA2203A, MSOX6004A, 53230A, 33522B, B2962A, 34470A, 34401A, L4534A, L4532A, U1620A, 3245A, 4284A+42841A) 、 ADCMT 7461A 、 AudioPrecision APx525 、 Fluke (8842A, 8846A, 190-104) 、 Tektronix (370A, TPS2024, TPS2014) 、 Keithley (2000, 2015) 、 Hioki (3390, 3196, 3197, PW3198) 、 IWATSU (CS3100, CS3200, CS3300, DG-8000, VOAC7602) 、 Kikusui (TOS-9201, TOS-6200, TOS-7200, TOS-3200, TOS-5101) 、 Lecroy (WR66Zi-HRO, HDO6104A-MS, DA1855A, DA1855A-PR2) 、 NF (FRA5097, FRA5087, WF1948, WF1974, WF1946, CK1620) 、 R&S AM300 、 SRS DS360 、 Tabor WW2074 、 Yokogawa (WT3000, WT1800, PX8000, DL750, SB5710, SL1000, DL7480) ..etc.

note: The names and logos mentioned in this catalog are the property of the mentioned companies

# Safety certification

## Electromagnetic Compatibility



DSP-Wx series

PDU series

## Low Voltage Directive



DSP-Wx series

PDU series

## Vibration Test & Filled Transport Packages

**KING DESIGN** Reliability & Communication Testing Instruments  
**KING DESIGN INDUSTRIAL CO., LTD.** VIBRATION LABORATORY  
 4F, NO. 3, Lane 276, Pui Shee Road Sec. 3, Shin Kong Hsin, New Taipei City, 222, Taiwan, R.O.C.  
 TEL: 886-2-2642-5198 FAX: 886-2-2642-3094  
 E-mail: lab@king-design.com.tw

TESTING / INSPECTION REPORT  
 REPORT NO : VT-170718-1

COMPANY : CHYNG HONG ELECTRONIC CO., LTD.  
 ADDRESS : No.80, Lane 258, Sec. 3, Hsin4 W. Rd., Beitun District, Taichung City Taiwan.  
 TEL : 886-4-2437-6268  
 FAX : 886-4-2437-6266  
 SPECIMEN : Package  
 DATE OF RECEIVED : 2017/07/14  
 DATE OF TESTED : 2017/07/14

TEST / INSPECTION ITEMS : Package Random Vibration Test  
 Package Drop Test

REMARKS :  
 The Laboratory is accredited by ISO/IEC 17025 General Requirements for the Competence of Calibration and Testing Laboratory.  
 The results only apply to the device under test.  
 This report is 17 pages, and no part of it may be abstracted or reproduced.

Test Engineer : Ken Wu  
 Approval Signature: David Lee Laboratory Head: Ching  
 Date: 2017.7.27

**KING DESIGN** Reliability & Communication Testing Instruments  
**KING DESIGN INDUSTRIAL CO., LTD.** VIBRATION LABORATORY  
 4F, NO. 3, Lane 276, Pui Shee Road Sec. 3, Shin Kong Hsin, New Taipei City, 222, Taiwan, R.O.C.  
 TEL: 886-2-2642-5198 FAX: 886-2-2642-3094  
 E-mail: lab@king-design.com.tw

TESTING / INSPECTION REPORT

TEST SPECIFICATION :

(3) Package Random Vibration Test  
 Test condition: Ref. IEC 61010-1  
 Frequency : 1 Hz to 200 Hz  
 Acceleration : 1.15G rms

Frequency (Hz)	G/Hz (PSD Level)
1.0	0.0001
4.0	0.01
100.0	0.01
200.0	0.001

Test Axis : 30 minutes for Face 3;  
 10 minutes for Face 1, Face 2 and Face 5

(4) Package Drop Test  
 Test condition : JIS Z 0200:2013  
 Drop Height : 30cm (300mm)  
 Drop Onto : 1 corner, 3 edges, 6 faces

TEST RESULT :

Function judgement	PASS	FAIL	Non-Judgment <sup>(1)</sup>
Appearance check	—	—	—

(1) - This test report record object test procedure and environment, not including test result.

**KING DESIGN** Reliability & Communication Testing Instruments  
**KING DESIGN INDUSTRIAL CO., LTD.** VIBRATION LABORATORY  
 4F, NO. 3, Lane 276, Pui Shee Road Sec. 3, Shin Kong Hsin, New Taipei City, 222, Taiwan, R.O.C.  
 TEL: 886-2-2642-5198 FAX: 886-2-2642-3094  
 E-mail: lab@king-design.com.tw

TESTING / INSPECTION REPORT

TEST SPECIFICATION :

(3) Package Random Vibration Test  
 Test condition: Ref. IEC 61010-1  
 Frequency : 1 Hz to 200 Hz  
 Acceleration : 1.15G rms

Frequency (Hz)	G/Hz (PSD Level)
1.0	0.0001
4.0	0.01
100.0	0.01
200.0	0.001

Test Axis : 30 minutes for Face 3;  
 10 minutes for Face 1, Face 2 and Face 5

(4) Package Drop Test  
 Test condition : JIS Z 0200:2013  
 Drop Height : 30cm (300mm)  
 Drop Onto : 1 corner, 3 edges, 6 faces

TEST RESULT :

Function judgement	PASS	FAIL	Non-Judgment <sup>(1)</sup>
Appearance check	—	—	—

(1) - This test report record object test procedure and environment, not including test result.

DSP-Wx series

## DSP-WR / WE Series



- 95% High Efficiency
- 0.99 PF (AC480V 3Ø Input)
- MHz Interleave Technology
- 5" 800x480LCD+Touch Screen
- Intuitive Human Interface

## DSP-WA / WAe Series

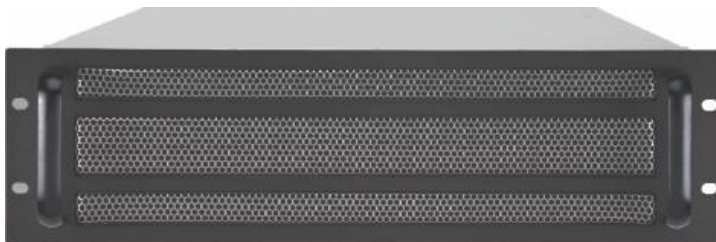

- LED Indicators
- Appropriate for ATE
- Master / Slave Unit

## Features

- **All Wide Range**; AC mains 180~460V, DC output 0~80V/540A to 0~1950V/27A.
- Maximum 3 power modules inside each with 3-phase ACV input, this design keeps AC mains balance and compliance with worldwide power distribution regulation.
- Output power 5kW ~ 18kW total 32 models.
- Built-in patented Synchronizing circuitry, easy to integrate 100 units to form a 1800kW power supply.
- Active power factor correction, PF>0.99(480V input).
- Efficiency >95%+. (\*2)

## Electrical

- MHz switching frequency(15kW and 18kW models), extremely low output ripple and noise. (\*3)
- Multiple 32 bit ARM based embedded system, fast boot time of 10 seconds or less.
- Use Wide Bandgap power semiconductors such as SiC MOSFET SBD, result in better performance, higher efficiency and lower heat dissipation..
- Adjustable output voltage, current and power.
- Constant Voltage(CV), Constant Current(CC) and Constant Power(CP) , CV. CC. or CP working priority setting.
- With internal resistance adjustment function to simulate characteristic of battery.
- Provide True RMS current and True Watt readings.
- 18 bit DAC for Setting and 24 bit ADC for Measurement.
- Built-in RTC, time is still reliable even when disconnected from time server.
- Customize time synchronization server possible.
- Remote sense functionality compensation voltage up to 5V.

## Operational

- 5" touch screen, 3 definable background colors, 3 spin knobs with tactile switch plus 2 buttons provide a excellent intuition operational experience.
- Patented Multi-function HOME/RETURN key.
- Patented output ON/OFF button provides extra layer of safety, only output when both internal switches are triggered.
- Two kind of output mode; output directly by adjustment or after confirmation.
- Programmable over voltage protection and over current protection.
- Programmable output ramp up and ramp down protecting the device under test.
- Up to 8000 sets of V/A/W data storage possible with time resolution of 1ms.
- Three sets of settings can be stored and recalled from the front panel.
- Free software provides control and sequence data setting.
- Data logging with timestamp.

## Safety

- Intelligent stepless speed controlled fans reduce acoustic noise and keep system temperature low.
- All models equip with auto-discharge circuit, discharge voltage to safe range within 10 sec. after output off.
- User definable power ON mode (LAST/OFF).
- Close case firmware upgrade with enhance protection design ensure successful system upgrade.
- CE approved , Filled Transport Packages approved and Vibration Test approved.

## Interface

- Built-in 2 LAN(LXI 1.4 approved) ports minimize wiring and reduce network complexity.
- Multi-purposed slot for optional interface; GPIB/Serial Port/Isolated Analog.
- Support SCPI commands.
- Provide IVI-COM driver.
- Alarm signal output and Interlock mechanism prevent possible injury.
- Optional isolated analog programming port, 0~5V or 0~10V for setting and monitoring output V/A/W.
- USB hotplug port provides easy data accessibility. (\*4)
- Free graphical connection and control software.(\*5)
- Easy comparision between wide range and traditional DC power supply with cumtomized software. (\*5)

## High Power/Current/Voltage Wide Range Output meet all Applications

- |                                |                       |                          |                   |
|--------------------------------|-----------------------|--------------------------|-------------------|
| ● Aerospace and Satellite Test | ● Battery Testing     | ● Sputtering and Coating | ● Heat Processing |
| ● Semiconductor Equipments     | ● Vehicle Electronics | ● Chemical Treatment     | ● QC Testing      |
| ● Solar Cell/Array Application | ● DC to DC Convertors | ● Water Purification     | ● LED Testing     |
| ● Contact/Connector Testing    | ● DC to AC Invertors  | ● Electronic Anti-rust   | ● Lighting        |
| ● Telecom and IT Industries    | ● New Energy R&D      | ● Factory Automation     | ● MOCVD           |
| ● Automated Test Equipment     |                       |                          |                   |

note : \*1: The ratio varies by model.

\*2: The efficiency varies by model and input voltage.

\*3: MHz switching frequency on selective models.

\*4: The format of USB flash drive should be FAT16(2GB) or FAT32(32GB) USB2.0).

\*5: Software available at iDRC website [www.idrc.com.tw](http://www.idrc.com.tw)

## Power rating (DSP-WR / DSP-WE / DSP-WA / DSP-WAe)

Output Power (22 models)	Models	Max. Voltage	Current @ Max. Voltage	Voltage @ Max. Current	Max. Current
		V1	A1	V2	A2
5kW (5 models)	DSP80-180□□	80 V	62.5 A	27.77 V	180 A
	DSP250-60□□	250 V	20 A	83.33 V	60 A
	DSP350-42□□	350 V	14.28 A	119.04 V	42 A
	DSP500-30□□	500 V	12 A	166.66 V	30 A
	DSP650-23□□	650 V	9.23 A	217.39 V	23 A
10kW (8 models)	DSP80-360□□	80 V	125 A	27.77 V	360 A
	DSP160-180□□	160 V	62.5 A	55.55 V	180 A
	DSP250-120□□	250 V	40 A	83.33 V	120 A
	DSP350-84□□	350 V	28.57 A	119.04 V	84 A
	DSP500-60□□	500 V	20 A	166.66 V	60 A
	DSP650-46□□	650 V	15.38 A	217.39 V	46 A
	DSP1000-30□□	1000 V	10 A	333.33 V	30 A
DSP1300-23□□	1300 V	7.69 A	434.78 V	23 A	
15kW (9 models)	DSP80-540□□	80 V	187.5 A	27.77 V	540 A
	DSP250-180□□	250 V	60 A	83.33 V	180 A
	DSP350-126□□	350 V	42.85 A	119.04 V	126 A
	DSP500-90□□	500 V	30 A	166.66 V	90 A
	DSP650-69□□	650 V	23.07 A	217.39 V	69 A
	DSP750-60□□	750 V	20 A	250 V	60 A
	DSP1050-42□□	1050 V	14.28 A	357.14 V	42 A
	DSP1500-30□□	1500 V	10 A	500 V	30 A
DSP1950-23□□	1950 V	7.69 A	650 V	23 A	

Output Power (10 models)	Models	Max. Voltage	Current @ Max. Voltage	Voltage @ Max. Current	Max. Current
		V1	A1	V2	A2
6kW (2 models)	DSP500-36□□	500 V	10 A	166.66 V	36 A
	DSP650-27□□	650 V	7.69 A	222.22 V	27 A
12kW (4 models)	DSP500-72□□	500 V	24 A	166.66 V	72 A
	DSP650-54□□	650 V	18.46 A	222.22 V	54 A
	DSP1000-36□□	1000 V	12 A	333.33 V	36 A
18kW (4 models)	DSP1300-27□□	1300 V	9.23 A	444.44 V	27 A
	DSP500-108□□	500 V	36 A	166.66 V	108 A
	DSP650-81□□	650 V	27.69 A	222.22 V	81 A
	DSP1500-36□□	1500 V	12 A	500 V	36 A
DSP1950-27□□	1950 V	9.23 A	666.66 V	27 A	

## Techniques Comparison

iDRC decades years of research and development into DC Power Supply that is more efficient and environmental friendly. Comparing with traditional DC Power Supply, DSP-Wx series has a number of advantages.

**15%** higher Efficiency

**1/6** of Size

**1/2** of Weight

**15** times faster

iDRC CDSP series

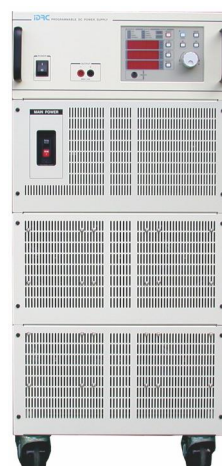

DSP-Wx 系列



18kW DC Power Supply



## Output Characteristic

State-of-the-art DSP-Wx provides various voltage and current combinations at full power. Conventional power supplies with rectangular output characteristics provide full power at only one voltage and current combination, but one DSP-Wx does the job of multiple power supplies, it's just like having 3 to 5 unit power supplies in one.

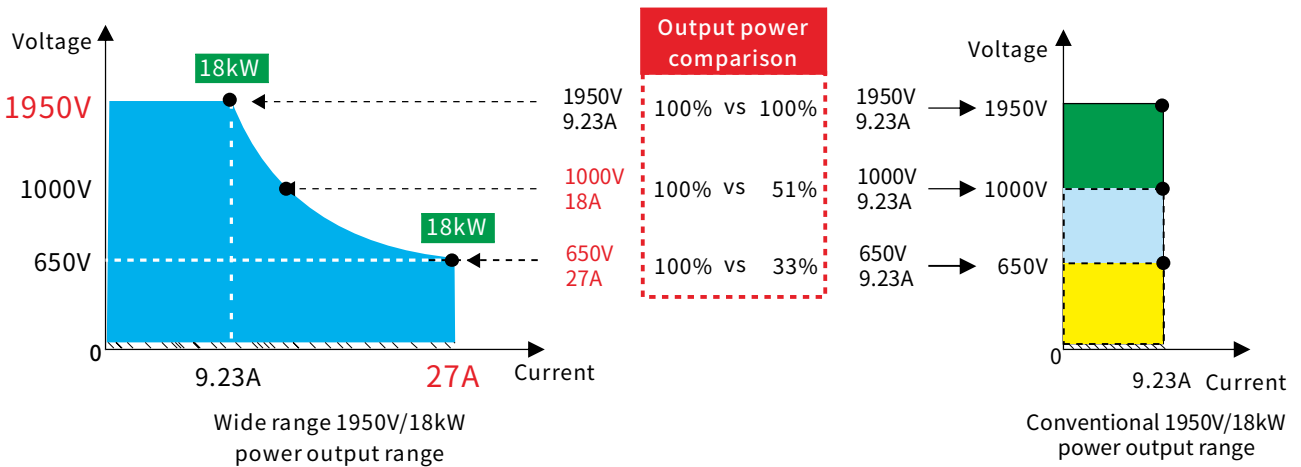

## MHz Switching Frequency

DSP-Wx multi-phase interleaved design boosts switching frequency to 1 MHz. Making DSP-Wx series world's first programmable DC power supply to reach MHz level. The higher frequency allows the system to output with minimal ripple, lightning fast response to load variation not achievable by other system.

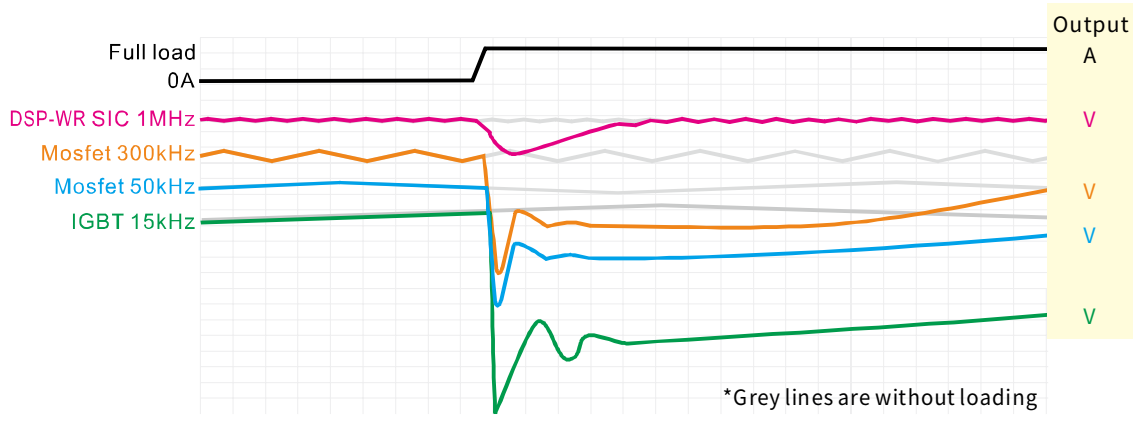

## Adjustable Ramp Up/Down

1. Adjustable ramp up/down during turn on/off stage, protecting sensitive load. Adjustable time range 0.1~99.9s.
2. Slew Rate of voltage, current or power(\*1) of DSP-WR will be changed according to working mode(CV/CC/CP) and the value of Slew Rate. Slew Rate setting range from 0.01%/ms to 100%/ms.

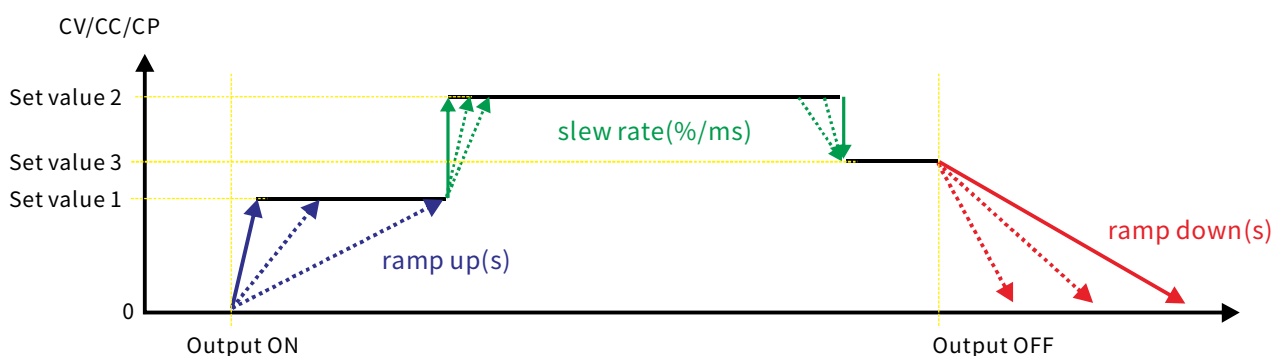

\*1. Exact Slew Rate in output off may influence by load.

## Output Protection

Despite DSP-Wx series has build-in Freewheeling Diode in confined space. High duty cycle and inductive load generate reverse EMF, having the Extra Freewheeling Diode ensure DC Power Supply is fully protected. Normally 20% higher in rating is chosen.

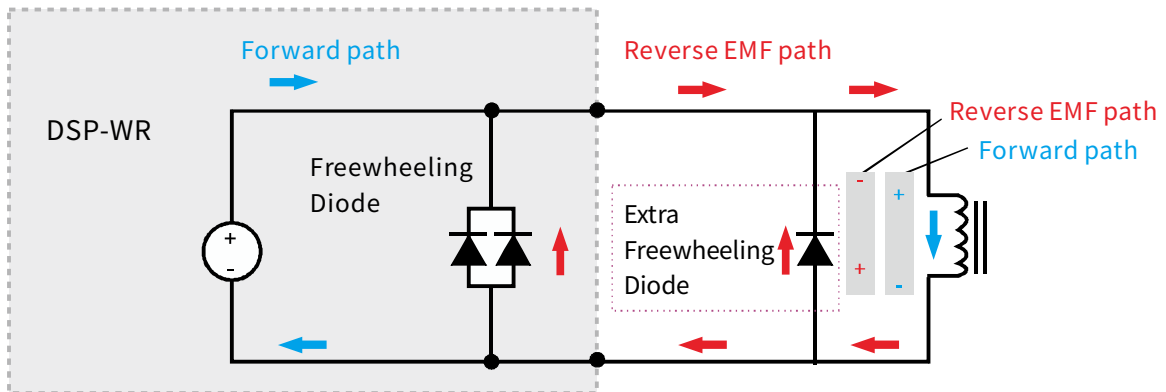

## Clear and Definite OUTPUT ON/OFF Control

iDRC always design product from user's perspectives. Clean and simple knob control on the front panel. Extra safe 2-tact-switch inside "OUTPUT" button to ensure proper switching at all time.

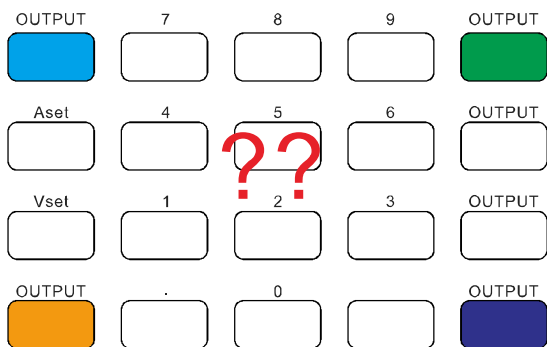

(Traditional all-in-one key pad with unclear symbol.)

VS.



## DSP-Wx Firmware Update

Update firmware easily with PC and WR-OPT-FUA adaptor.

**RISK FREE**

Enhanced safety mechanism to prevent any firmware update failure.

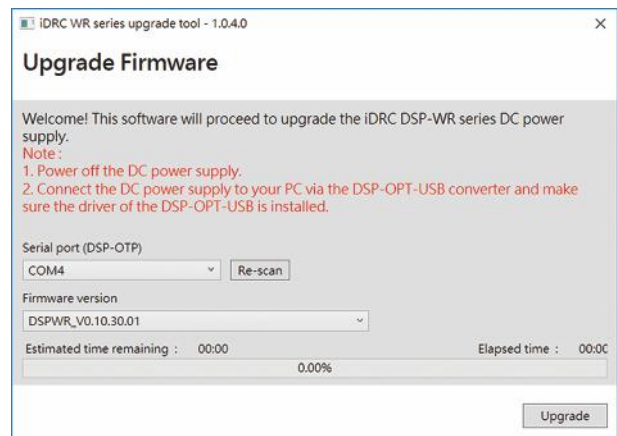

## Auto-discharge

DSP-Wx series built-in Auto-discharge circuit, automatically dissipate energy to around 60V in 10 seconds after output off.

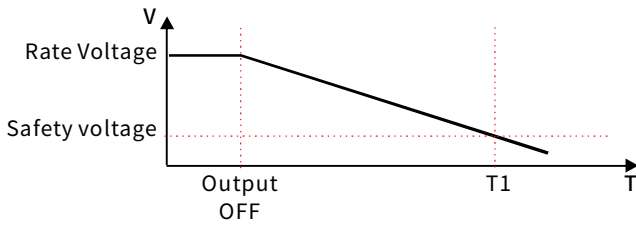

No load down time

Model	T1	Model	T1	Model	T1
80V	5 sec	650V	6 sec	1500V	5 sec
160V	10 sec	750V	10 sec	1950V	6 sec
250V	10 sec	1000V	5 sec		
350V	10 sec	1050V	10 sec		
500V	5 sec	1300V	6 sec		

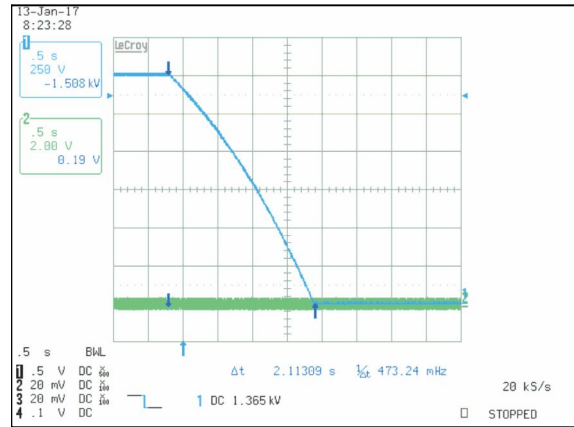

DSP1500-30WR 2.11 seconds discharging time at full loading

## Output Capacitance

DSP-Wx series output capacitance as follows:

model	80V	160V	250V	350V	500V	650V	750V	1000V	1050V	1300V	1500V	1950V
5kW	4230μF	--	1350μF	738μF	115μF	115μF	--	--	--	--	--	--
6kW	--	--	--	--	115μF	115μF	--	--	--	--	--	--
10kW	8460μF	2115μF	2700μF	1476μF	230μF	230μF	--	57.5μF	--	57.5μF	--	--
12kW	--	--	--	--	230μF	230μF	--	57.5μF	--	57.5μF	--	--
15kW	12690μF	--	4050μF	2214μF	345μF	345μF	450μF	--	246μF	--	38.3μF	38.3μF
18kW	--	--	--	--	345μF	345μF	--	--	--	--	38.3μF	38.3μF

## Internal Resistance Simulation

Battery-powered electronics are more and more commonly found.

DSP-Wx series built-in unique Internal Resistance Simulation function be able to simulate battery behaviour with 5-digit accuracy.

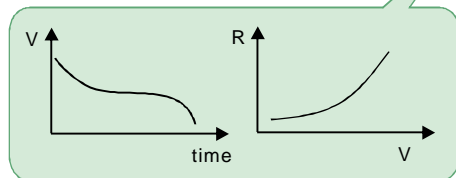
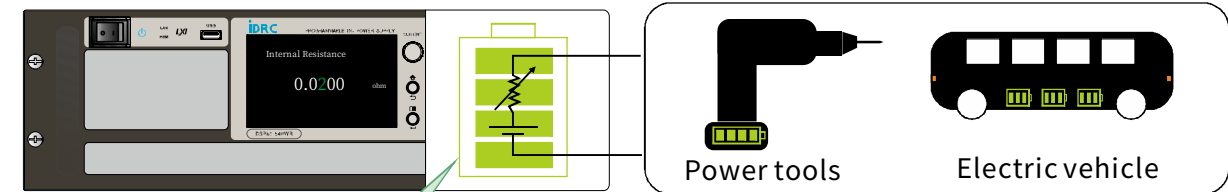

5kW model	Internal R range
DSP80-180Wx	0~0.4444Ω
DSP250-60Wx	0~4.1667Ω
DSP350-42Wx	0~8.3333Ω
DSP500-30Wx	0~16.667Ω
DSP650-23Wx	0~28.261Ω

6kW model	Internal R range
DSP500-36WR	0 ~ 13.888Ω
DSP650-27WR	0 ~ 24.074Ω

10kW model	Internal R range
DSP80-360Wx	0 ~ 0.2222Ω
DSP160-180Wx	0 ~ 0.8888Ω
DSP250-120Wx	0 ~ 2.0833Ω
DSP350-84Wx	0 ~ 4.1667Ω
DSP500-60Wx	0 ~ 8.3333Ω
DSP650-46Wx	0 ~ 14.130Ω
DSP1000-30Wx	0 ~ 33.333Ω
DSP-1300-23Wx	0 ~ 56.521Ω

12kW model	Internal R range
DSP500-72Wx	0 ~ 6.9444Ω
DSP650-54Wx	0 ~ 12.037Ω
DSP1000-36Wx	0 ~ 27.777Ω
DS1300-27Wx	0 ~ 48.148Ω

15kW model	Internal R range
DSP80-540Wx	0 ~ 0.1481Ω
DSP250-180Wx	0 ~ 1.3889Ω
DSP350-126Wx	0 ~ 2.7778Ω
DSP500-90Wx	0 ~ 5.5556Ω
DSP650-69Wx	0 ~ 9.4203Ω
DSP750-60Wx	0 ~ 12.500Ω
DSP1050-42Wx	0 ~ 25.000Ω
DSP1500-30Wx	0 ~ 50.000Ω
DSP1950-23Wx	0 ~ 84.782Ω

18kW model	Internal R range
DSP500-108Wx	0 ~ 4.6296Ω
DSP650-81Wx	0 ~ 8.0246Ω
DSP1500-36Wx	0 ~ 41.666Ω
DSP1950-27Wx	0 ~ 72.222Ω

## DSP-WS Series



## DSP-WAs Series

- Easily and accurately simulate solar array I-V characteristic for PV invertors evaluating. Two modes of creating desire I-V curve, Curve mode and Table mode. With Curve mode, only need to set four parameters through either the Graphical Software (Free download from iDRC website) or input directly on the front panel. With table mode, user can shape an I-V curve by entering between 3 to 1024 points. DSP-WS/As will automatically enhances the resolution to 8,000 points to generate a smooth curve.

$V_{oc}$  : Open circuit voltage  
 $V_{mp}$  : Voltage at maximum power  
 $I_{sc}$  : Short circuit current  
 $I_{mp}$  : Current at maximum power

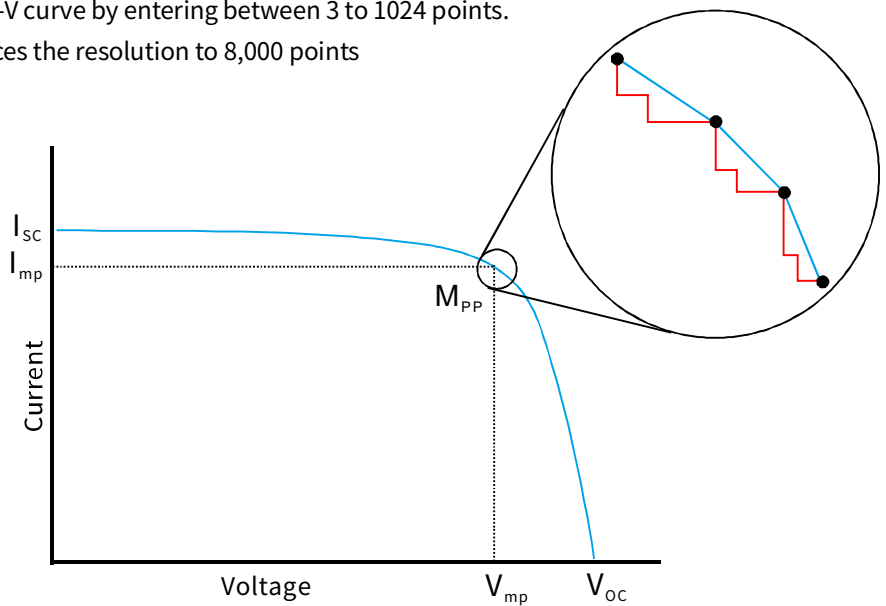

## ⦿ Solar Array Simulator (DSP-WS / DSP-WAs)

Output Power (8 models)	Models	Max. Voltage	Current @ Max. Voltage	Voltage @ Max. Current	Max. Current
		V1	A1	V2	A2
10kW (2 models)	DSP1000-30WS / As	1000 V	10 A	333.33 V	30 A
	DSP1300-23WS / As	1300 V	7.69 A	434.78 V	23 A
12kW (2 models)	DSP1000-36WS / As	1000 V	12 A	333.33 V	36 A
	DSP1300-27WS / As	1300 V	9.23 A	444.44 V	27 A
15kW (2 models)	DSP1050-42WS / As	1050 V	14.28 A	357.14 V	42 A
	DSP1500-30WS / As	1500 V	10 A	500 V	30 A
	DSP1950-23WS / As	1950 V	7.69 A	650 V	23 A
18kW (2 models)	DSP1500-36WS / As	1500 V	12 A	500 V	36 A
	DSP1950-27WS / As	1950 V	9.23 A	666.66 V	27 A

## Feature

- With solar array simulation function, imitate output characteristic of various Solar Array.
- Curve Mode and Table Mode 2 types I/V curve, up to 8192 setting points to form a smooth and realistic waveform.
- Graphic control software meets EN50530 requirement for free.
- Simulation of IV curve of solar array in different temperature and lux
- Static & Dynamic MPPT efficiency test(accumulated energy method) and log file generating.
- Real time Maximum Power Point Tracing via remote interface.
- Versatile working modes: I/V curve, constant voltage, constant current and constant power.
- The setting of I/V curve can download to DSP-WS series via interface or memory stick to USB port.
- Multi-tasking function allows to control up to 12 units of DSP-WS Solar Array simulator.
- 18 bit DAC for setting and 24 bit ADC for measuring.

## I/V curve editor screenshot (DSP-WS / DSP-WAs Series)



I/V curve- EN 50530

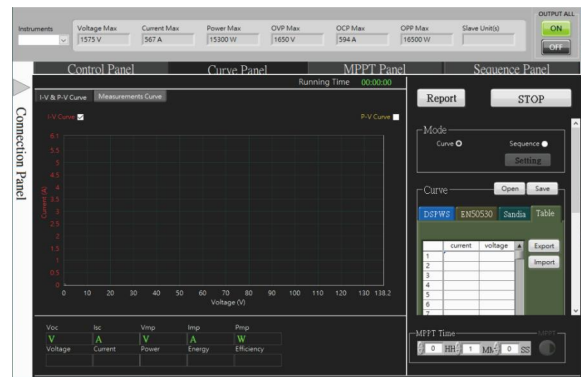

I/V curve- Table mode

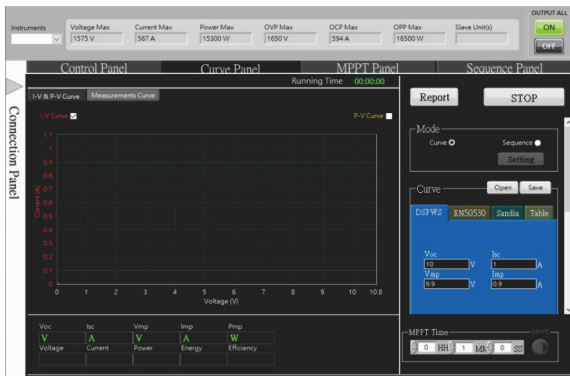

I/V curve- I-V curve

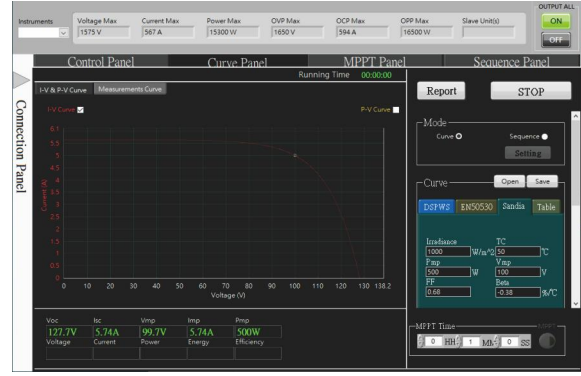

I/V curve- Sandia

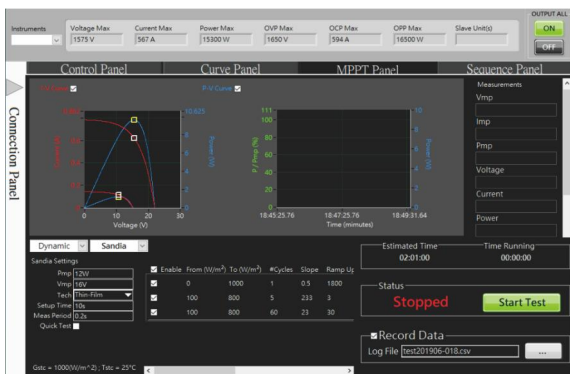

MPPT-Dynamic

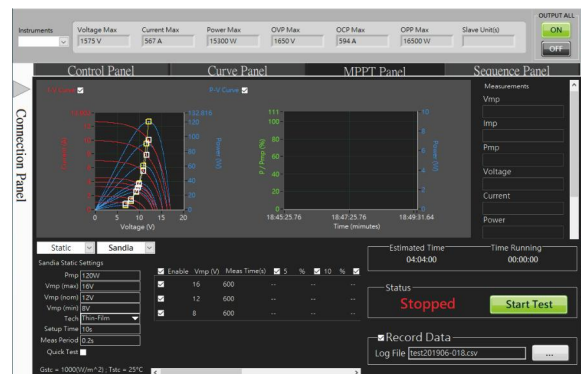

MPPT-Static

## Front Panel

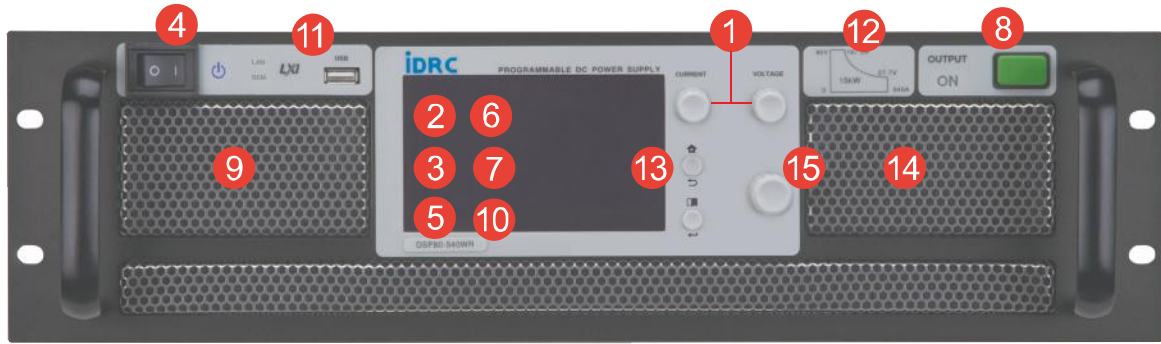

**1**

Modern and classical design with individual knob for voltage, current and power control, press to select the digit and rotate to change value.

**2**

**Complete Mode:**  
Voltage, Current, Power and Time settings on one screen. Three sets of memory to store/recall settings.

**3**

**Simple Mode:**  
Only Voltage and Current are adjustable, power will be forced to rated power.

**4**

High quality power switch with safety guard to sufficiently prevent accidental operation.

**5**

ARM Cortex-A9<sup>(note)</sup> graphical microprocessor brings smooth operation and fast response.

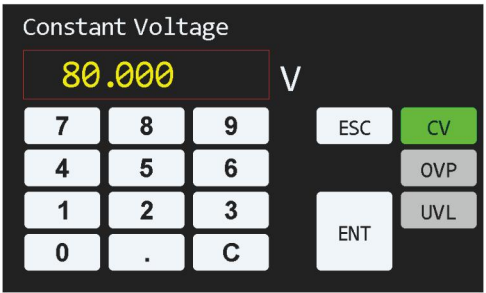
**6**  **Constant Voltage**  
80.000 V  
7 8 9 ESC CV  
4 5 6 OVP  
1 2 3 ENT UVL  
0 . C

Enter value with numeric pad. Output voltage, OVP and UVP settings on one screen.

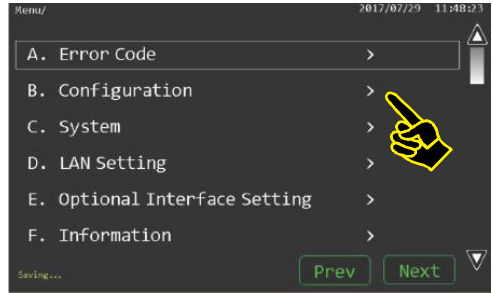
**7**  **Menu** 2017/07/29 11:48:23  
A. Error Code >  
B. Configuration >  
C. System >  
D. LAN Setting >  
E. Optional Interface Setting >  
F. Information >  
Saving... Prev Next

All characters in full spelling.

**8**  **Double SAFE**  
Patented 2 tact switches inside Output On/Off Switch

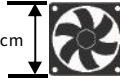
**9**  Equipped with high quality 12x12 cm speed-controlled fan. Rated speed: 4500rpm, Air flow: 150CFM. Reduces noise effectively. Ensure sufficient cooling.

**10**  High resolution TFT LCD 800 x 480 WVGA and resistive touchscreen

**11**  USB TYPE A connector access USB flash memory up to 32GB.

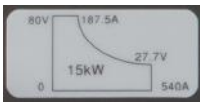
**12**  Wide Range Labeling  
Easy to obtain the maximum combinative values of voltage and current

**13**  Innovative HOME key  
Tap the HOME key to return to the previous page, press and hold for 1.5 seconds to return to the main page.

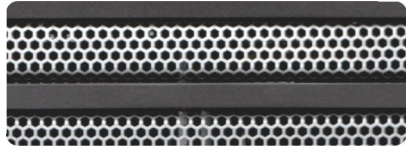
**14**  Eco-friendly paintless/non-plated stainless steel intake.  
Hexagon shape net maximizes ventilation airflow.

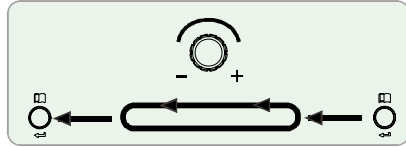
**15**  Function select either by touchscreen or unique hybrid-task spin knob.

## Remote Control Interface

**6** LXI interface (Standard)  

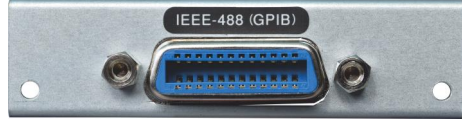

**7** Isolated analog interface (Optional)  

**8** GPIB interface (Optional)  

**9** RS-422 & 485 / USB interface (Optional)  

## Rear Panel

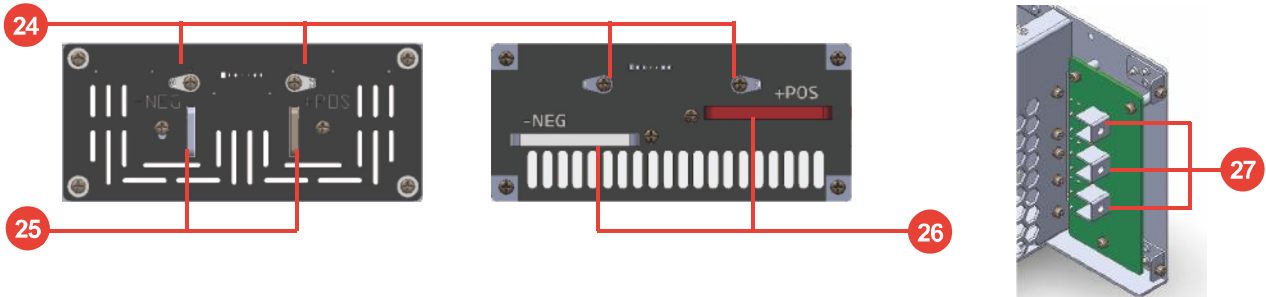
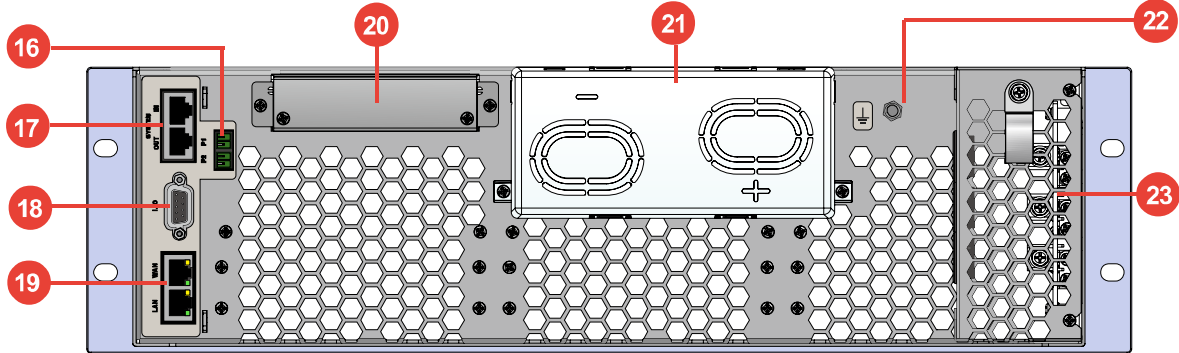
- 16 Current sharing
- 17 System IN/OUT
- 18 Auxiliary control
- 19 LAN (LXI) connector
- 20 Slot for optional interfaces
- 21 Output terminals and cover
- 22 Ground terminal (earth terminal)
- 23 Input protective cover
- 24 Remote sense/compensation terminal
- 25 Output terminals
- 26 Output terminals (80V/10kW & 15kW)
- 27 AC input terminals



## Dimensions (mm)

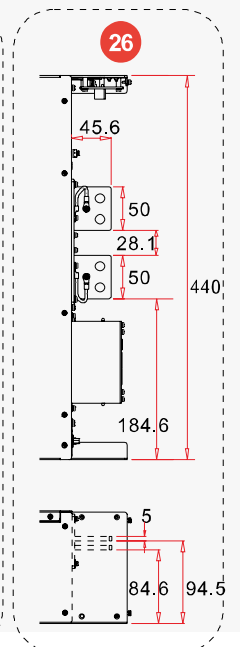
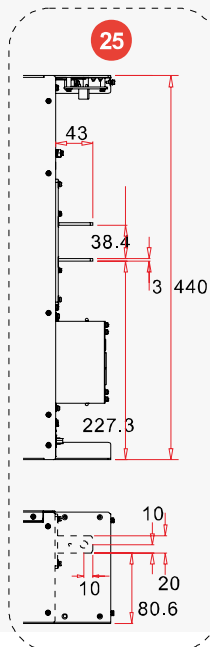
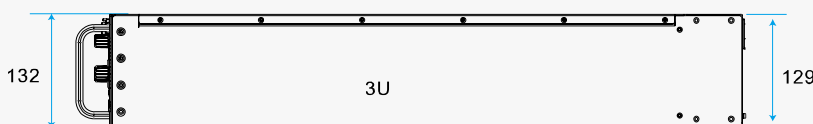
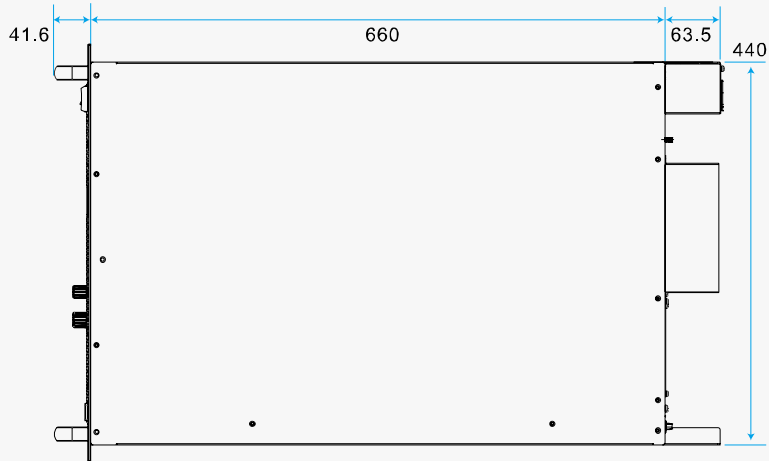
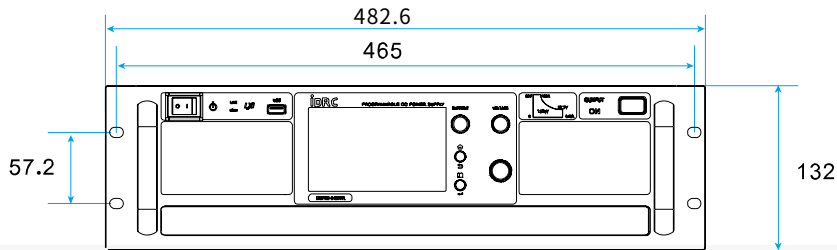



# Master/Slave Configuration

The pre-assembled rack with Power Distribution Unit is available for selection.

- **Paralleling up to 100 units**  
Up to 1,800kW  
Up to 54,000A (80V model)
- Master automatically detects all slave units.
- Surplus slave unit(s) can be off to save energy. (\*1)
- Zero gap stacking, superior power density.  
180kW in 30U rack
- Aggregated display  
Master unit controls and displays the actual values of entire system.
- Ultra-fast synchronization  
Up to several Mbps of synchronization, extremely low ripple.
- Smart PDU  
Full remote control.  
Sequential power on/off of slaves.  
Monitoring power quality and power consumption.

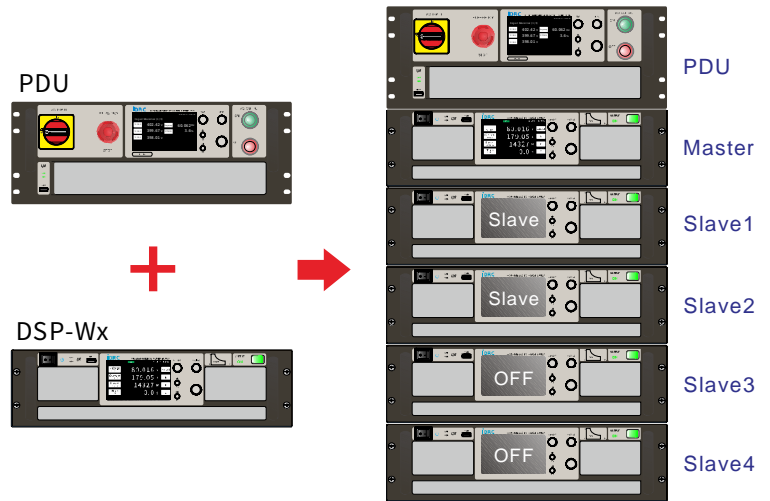

\*1 : Switch Off from the last unit

- **Expand the Power Capacity**  
DSP-Wx and DSP-WAx (blank panel) series Programmable DC Power Supply allows 100 units paralleling to expand the power capacity, the features as follows:
  - Even though 5kW or 10 kW models can be paralleled to form a power system.
  - DSP-WAx series (blank panel) model be able to play as a master.
  - Flexible and versatile integration, next with examples :

**Mode 1: 1 unit of DSP-WR/E (Master) + N units of DSP-Wx (Slave)**  
User can manipulate and have readings on panel or via interface.

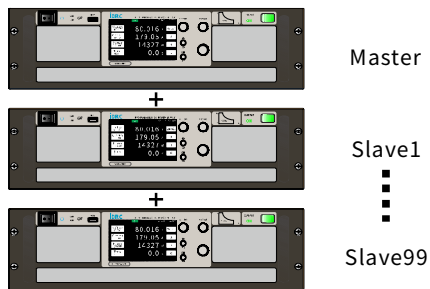

**Mode 3: 1 unit of DSP-WR/E (Master) + N units of DSP-WAx (Slave)**  
The most typical power system associated by one full function model as the master plus blank panel models, all controls and readings aggregate to master unit.

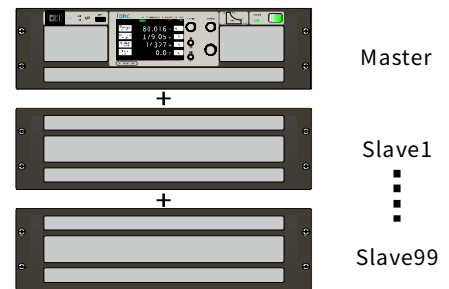

**Mode 2: 1 unit of DSP-WAx (Master) + N units of DSP-WAx (Slave)**  
There are master/slave setting switch and indicators behind the intake of DSP-WAx series Programmable DC Power Supply. All operation and display are made by a PC via interface.

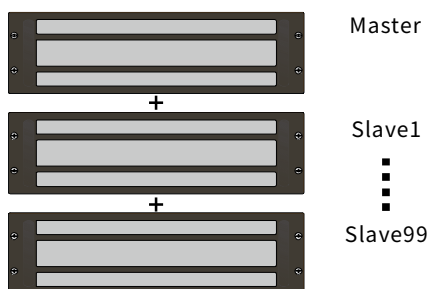

**Mode 4: 1 unit of DSP-WR/E or DSP-WAx (Master) + N units of DSP-WR/E or DSP-WAx (Slave)**  
Any one model of DSP-Wxx series be able to play as master or slave, this versatile feature allows user to integrate a power system with any kind of DSP-Wxx models in case of the same voltage and power ratings.

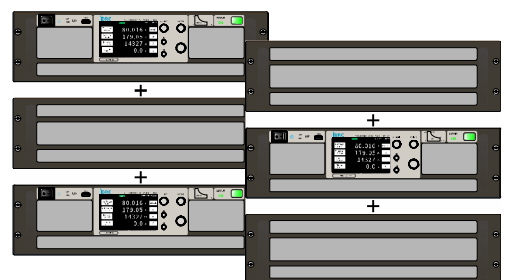

## Application

### Diode, Laser Diode, LED, Power Chip Testing

DSP-Wx series provides CV(Constant Voltage), CC(Constant Current) and CP(Constant Power) modes, it allows user to select suitable mode correspond to test requirement.

Below shows an application of CC mode avoiding any current/voltage overshoot during diode validation.

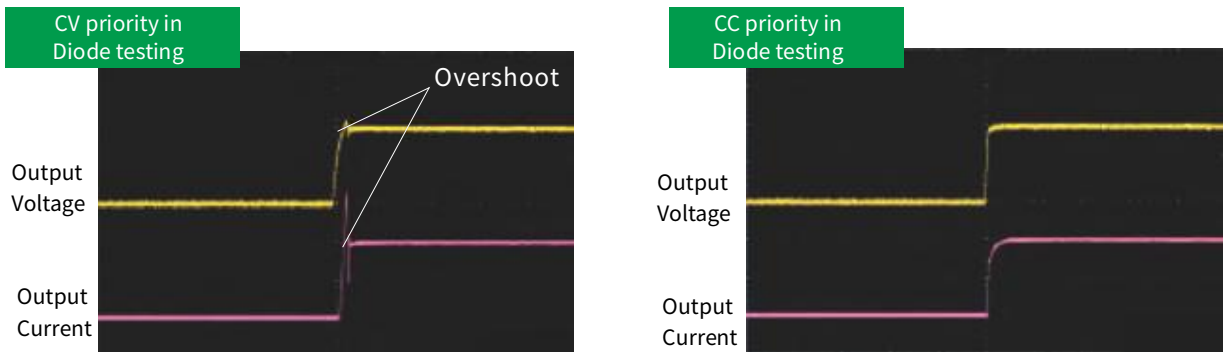

### Lead Acid /Lithium Battery Testing

- iDRC wide range DC Power Supply can adjust output range to fit various battery layout. Eliminate large number of purpose built power supplies.
- By using DSP-Wx series DC Power Supply, one unit can reach high voltage/low current and low voltage/high current, it significantly reduce cost and space of test equipment.
- DSP-Wx series Wide Range DC Power Supply with sufficient current and voltage capacity to test batteries in parallel or series.

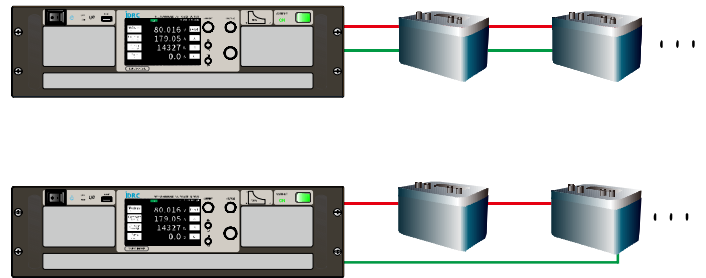

### ATE Integration

- DSP-WA/WAe/WAs series without front panel are suitable for ATE and slave unit application.
- Full function design capable of master unit.
- Equip with various indicators to show operating conditions, convenient for visual checking.

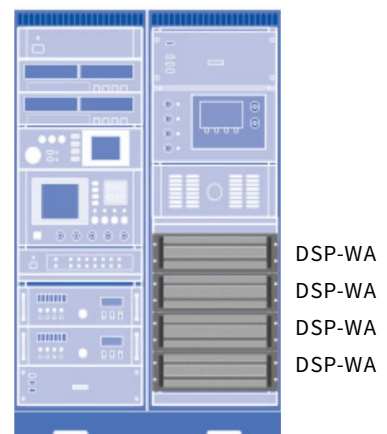
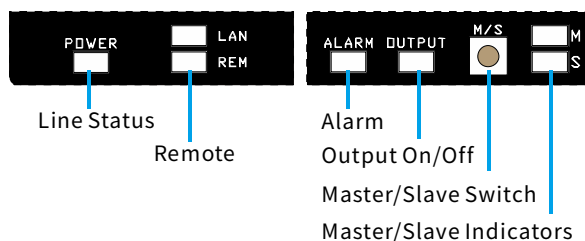

DSP-WA  
DSP-WA  
DSP-WA  
DSP-WA

## Application

### Electric/Hybrid Vehicle and General Motor Testing

While electric vehicle pursue even better endurance and energy conversion efficiency, there is an ever-rising demand in highly flexible and capable DC power supply.

DSP-Wx series DC power supply provides 5kW-1800kW wide range voltage/current control.

Capable to adjust to all test scenario.

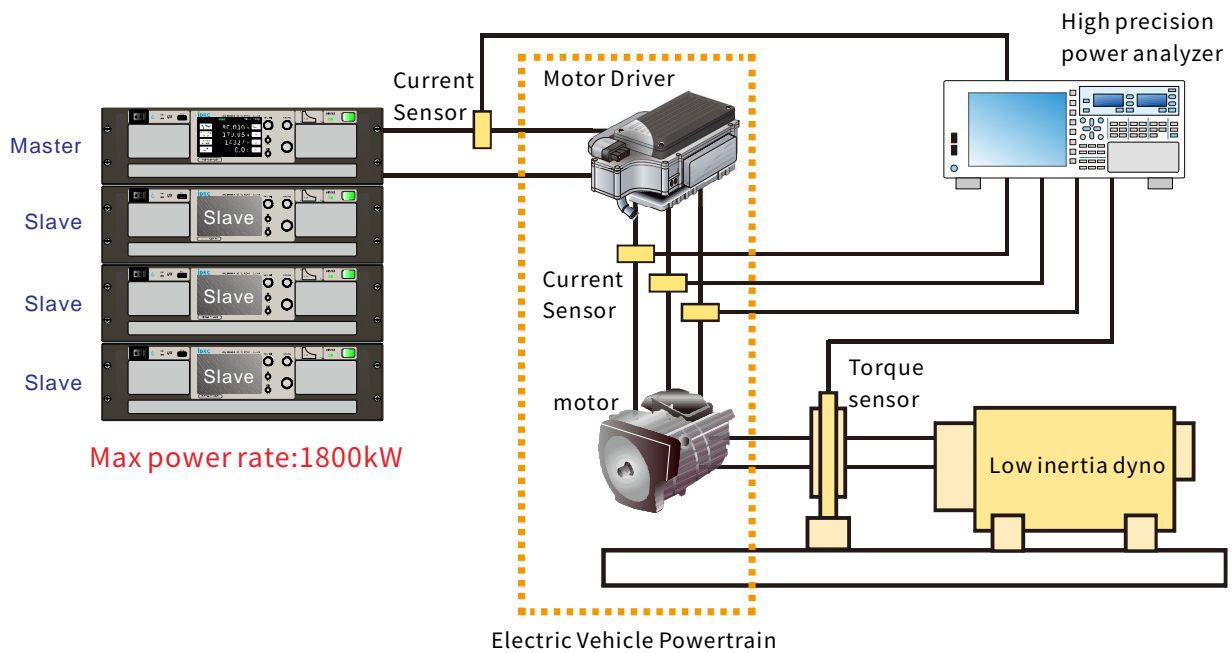

### Power Conditioning of Solar Array and Fuel Cell Testing

DSP-WS series power supply simulates output of solar array and fuel cell, capable of testing wide range of products to meet domestic/commercial regulation.

Commercial Solar array Power System voltage rating has improved from 1000V to 1500V.

High voltage will require less current to achieve the same power rating. Hence new generation solar cell array usually has high loop voltage to simplify wiring, reduce capital expenditure and lower running cost.

DSP-WS DC Power Supply 1950V output meets the demand of high voltage testing.

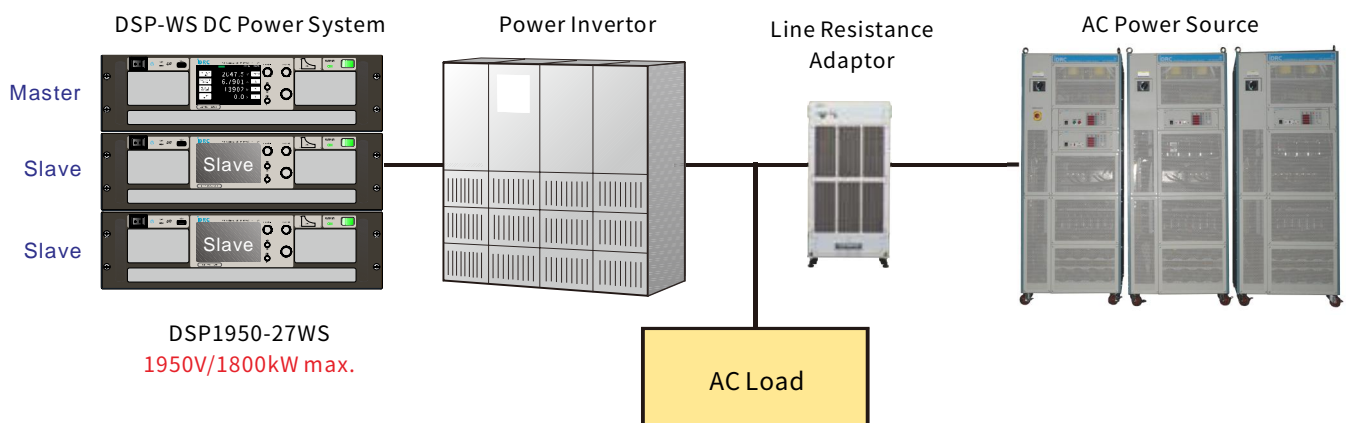

## Wide Range Power Supply versus Conventional Power Supply

This application software is compatible with DSP-WR, DSP-WE, DSP-WS, DSP-WA, DSP-WAs and DSP-WAe Series Wide Range Programmable DC Power Supply.

- Display output characteristic curve.
- Compare power range of Wide Range Model with Conventional Model
- Display value anywhere on the curve.
- Report Printing
- Show off the output value including:  
Current at maximum voltage  
Voltage at maximum current  
The difference in current

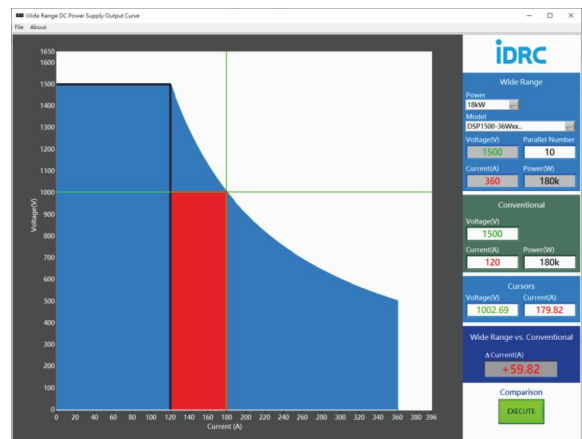

## GUI software

This application software is compatible with DSP-WR, DSP-WE, DSP-WS, DSP-WA, DSP-WAs and DSP-WAe Series Wide Range Programmable DC Power Supply.

- Automatic search and connect to DSP-Wx Series Power Supply
- Set and acquire all parameters and readings from DSP-Wx Series Power Supply.
- Save/Load Sequence Mode settings.
- Send sequence data to connected device or save to USB drive



<Virtual Panel>



<Sequence Performing>

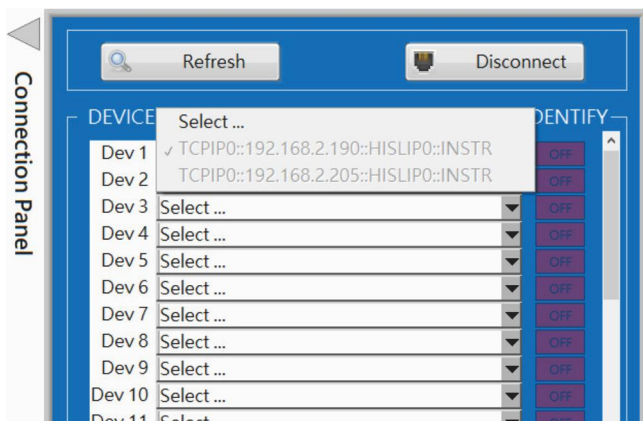

<Multi Devices Connection>

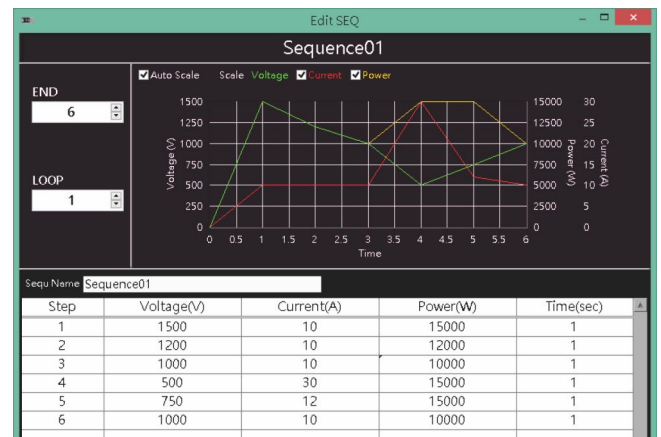

<Sequence Editing>

## 5kW ~ 10kW Specifications

Rated Power		5kW	5kW	5kW	5kW	5kW	10kW
Model number		DSP80-180W□□	DSP250-60W□□	DSP350-42W□□	DSP500-30W□□	DSP650-23W□□	DSP80-360W□□
Rated Voltage		80V	250V	350V	500V	650V	80V
Rated Current		180A	60A	42A	30A	23A	360A
<b>Constant Voltage</b>							
Rated value		0~80V	0~250V	0~350V	0~500V	0~650V	0~80V
Settable range		0~84V	0~262.5V	0~367.5V	0~525V	0~682.5V	0~84V
Over voltage protection (OVP)		0%~110% of rated output voltage					
Voltage @ Max. Current		27.77V	83.33V	119.04V	166.66V	217.39V	27.77V
Programming resolution		5 digits					
Programming accuracy(*2)		±0.1% of rated voltage					
Meter resolution		5 digits					
Meter accuracy(*2)		± 0.1% of rated voltage					
Line regulation(*6)		±0.02% of rated voltage (with local sense)					
Load regulation(*7)		±0.05% of rated voltage (with local sense)					
Temperature coefficient for set values		100ppm/°C of rated output voltage, after a 30 minutes warm-up					
Ripple & noise(*3)(*4)	Vpp	<180mV	<270mV	<288mV	<315mV	<720mV	<288mV
	Vrms	<15mV	<36mV	<50mV	<63mV	<180mV	<23mV
Full load up		<30ms					
Full load down		<80ms					
No load down		<5s	<10s	<10s	<5s	<6s	<5s
Transient Response		<1.5ms					
Remote Compensation		5V					
<b>Constant Current</b>							
Rated value		0~180A	0~60A	0~42A	0~30A	0~23A	0~360A
Settable range		0~189A	0~63A	0~44.1A	0~31.5A	0~24.15A	0~378A
Over current protection (OCP)		0%~110% of rated output current					
Current @ Max. Voltage		62.5A	20A	14.28A	10A	7.69A	125A
Programming resolution		5 digits					
Programming accuracy(*2)		±0.2% of rated current					
Meter resolution		5 digits					
Meter accuracy(*2)		± 0.2% of rated current					
Line regulation(*6)		±0.05% of rated current					
Load regulation(*7)		±0.15% of rated current					
Temperature coefficient for set values		100ppm/°C of rated output voltage, after a 30 minutes warm-up					
Ripple & noise(*3)(*4)	Arms	72mA	20mA	16mA	15mA	15mA	144mA
<b>Constant Power</b>							
Rated value		0~5kW	0~5kW	0~5kW	0~5kW	0~5kW	0~10kW
Settable range		0~5100W	0~5100W	0~5100W	0~5100W	0~5100W	0~10200W
Over power protection (OPP)		0%~110% of rated output current					
Programming resolution		5 digits					
Programming accuracy		< 1% of rated power					
Meter resolution		5 digits					
Meter accuracy(*2)		± 0.5% of rated power					
Line regulation(*6)		< 0.05% of rated power					
Load regulation(*7)		< 0.75% of rated power					
<b>Internal resistance (*9)</b>							
Adjustment range		0~0.4444Ω	0~4.1667Ω	0~8.3333Ω	0~16.667Ω	0~28.261Ω	0~0.2222Ω
Programming resolution		0.0001Ω	0.0001Ω	0.0001Ω	0.001Ω	0.001Ω	0.0001Ω
Programming Accuracy(*2)		≤2.3% of max. resistance					
<b>Input</b>							
Nominal input rating		200~415V 50Hz/60Hz 3-phase 3 wires , Optional 480V 50/60Hz 3-phase 4 wires					
Input voltage range		180~460VAC , Optional 480VAC type:432~528VAC					
Input frequency range		47Hz~63Hz					
Current (Maximum)(Input 3P180V)		20A/phase	20A/phase	20A/phase	20A/phase	20A/phase	40A/phase
Inrush current(Input 3P 460V)		33A/phase	33A/phase	33A/phase	33A/phase	33A/phase	66A/phase
Input Power (Maximum)		6kVA	6kVA	6kVA	6kVA	6kVA	12kVA
Efficiency		86~95% varies by model(*1)					
Leakage current		< 3.5 mA					
Power Factor		0.99 typ.(480V input) / 0.95 typ.(200-415V input)					
<b>Insulation</b>							
Primary - Chassis		DC 2500V					
Primary - Secondary		DC 2500V					
Secondary - Chassis		DC750V	DC750V	DC750V	DC1000V	DC1500V	DC750V
<b>Weights and dimensions</b>							
Dimensions(WxHxD)		Enclosure : 440 x 129 x 660 mm , Total : 482 x 132 x 765.1 mm					
Weight (kg)		27.5	26	26	26	26	36.3

## 10kW Specifications

Rated Power	10kW	10kW	10kW	10kW	10kW	10kW
Model number	DSP160-180W□□	DSP250-120W□□	DSP350-84W□□	DSP500-60W□□	DSP650-46W□□	DSP1000-30W□□
Rated Voltage	160V	250V	350V	500V	650V	1000V
Rated Current	180A	120A	84A	60A	46A	30A
<b>Constant Voltage</b>						
Rated value	0~160V	0~250V	0~350V	0~500V	0~650V	0~1000V
Settable range	0~168V	0~262.5V	0~367.5V	0~525V	0~682.5V	0~1050V
Over voltage protection (OVP)	0%~110% of rated output voltage					
Voltage @ Max. Current	55.55V	83.33V	119.04V	166.66V	217.39V	333.33V
Programming resolution	5 digits					
Programming accuracy(*2)	±0.1% of rated voltage					
Meter resolution	5 digits					
Meter accuracy(*2)	± 0.1% of rated voltage					
Line regulation(*6)	±0.02% of rated voltage (with local sense)					
Load regulation(*7)	±0.05% of rated voltage (with local sense)					
Temperature coefficient for set values	100ppm/°C of rated output voltage, after a 30 minutes warm-up					
Ripple & noise(*3)(*4)	Vpp	<432mV	<270mV	<288mV	<315mV	<720mV
	Vrms	<35mV	<36mV	<50mV	<63mV	<180mV
Full load up	<30ms					
Full load down	<80ms					
No load down	<5s	<10s	<10s	<5s	<6s	<10s
Transient Response	<1.5ms					
Remote Compensation	5V					
<b>Constant Current</b>						
Rated value	0~180A	0~120A	0~84A	0~60A	0~46A	0~30A
Settable range	0~189A	0~126A	0~88.2A	0~63A	0~48.3A	0~31.5A
Over current protection (OCP)	0%~110% of rated output current					
Current @ Max. Voltage	62.5A	40A	28.57A	20A	15.38A	10A
Programming resolution	5 digits					
Programming accuracy(*2)	±0.2% of rated current					
Meter resolution	5 digits					
Meter accuracy(*2)	± 0.2% of rated current					
Line regulation(*6)	±0.05% of rated current					
Load regulation(*7)	±0.15% of rated current					
Temperature coefficient for set values	100ppm/°C of rated output voltage, after a 30 minutes warm-up					
Ripple & noise(*3)(*4)	Arms	72mA	40mA	32mA	29mA	20mA
<b>Constant Power</b>						
Rated value	0~10kW	0~10kW	0~10kW	0~10kW	0~10kW	0~10kW
Settable range	0~10200W	0~10200W	0~10200W	0~10200W	0~10200W	0~10200W
Over power protection (OPP)	0%~110% of rated output current					
Programming resolution	5 digits					
Programming accuracy	< 1% of rated power					
Meter resolution	5 digits					
Meter accuracy(*2)	± 0.5% of rated power					
Line regulation(*6)	< 0.05% of rated power					
Load regulation(*7)	< 0.75% of rated power					
<b>Internal resistance (*9)</b>						
Adjustment range	0~0.8888Ω	0~2.0833Ω	0~4.1667Ω	0~8.3333Ω	0~14.130Ω	0~33.333Ω
Programming resolution	0.0001Ω	0.0001Ω	0.0001Ω	0.0001Ω	0.001Ω	0.001Ω
Programming Accuracy(*2)	≤2.3% of max. resistance					
<b>Input</b>						
Nominal input rating	200~415V 50Hz/60Hz 3-phase 3 wires , Optional 480V 50/60Hz 3-phase 4 wires					
Input voltage range	180~460VAC , Optional 480VAC type:432~528VAC					
Input frequency range	47Hz~63Hz					
Current (Maximum)(Input 3P 180V)	40A/phase	40A/phase	40A/phase	40A/phase	40A/phase	40A/phase
Inrush current(Input 3P 460V)	66A/phase	66A/phase	66A/phase	66A/phase	66A/phase	66A/phase
Input Power (Maximum)	12kVA	12kVA	12kVA	12kVA	12kVA	12kVA
Efficiency	86~95% varies by model(*1)					
Leakage current	< 3.5 mA					
Power Factor	0.99 typ.(480V input) / 0.95 typ.(200-415V input)					
<b>Insulation</b>						
Primary - Chassis	DC 2500V					
Primary - Secondary	DC 2500V					
Secondary - Chassis	DC750V	DC750V	DC750V	DC1000V	DC1500V	DC1500V
<b>Weights and dimensions</b>						
Dimensions(WxHxD)	Enclosure : 440 x 129 x 660 mm , Total : 482 x 132 x 765.1 mm					
Weight (kg)	36.3	34.8	34.8	34.8	34.8	34.8

## 10kW ~ 15kW Specifications

Rated Power	10kW	15kW	15kW	15kW	15kW	15kW
Model number	DSP1300-23W□□	DSP80-540W□□	DSP250-180W□□	DSP350-126W□□	DSP500-90W□□	DSP650-69W□□
Rated Voltage	1300V	80V	250V	350V	500V	650V
Rated Current	23A	540A	180A	126A	90A	69A
<b>Constant Voltage</b>						
Rated value	0~1300V	0~80V	0~250V	0~350V	0~500V	0~650V
Settable range	0~1365V	0~84V	0~262.5V	0~367.5V	0~525V	0~682.5V
Over voltage protection (OVP)	0%~110% of rated output voltage					
Voltage @ Max. Current	434.78V	27.77V	83.33V	119.04V	166.66V	217.39V
Programming resolution	5 digits					
Programming accuracy(*2)	±0.1% of rated voltage					
Meter resolution	5 digits					
Meter accuracy(*2)	± 0.1% of rated voltage					
Line regulation(*6)	±0.02% of rated voltage (with local sense)					
Load regulation(*7)	±0.05% of rated voltage (with local sense)					
Temperature coefficient for set values	100ppm/°C of rated output voltage, after a 30 minutes warm-up					
Ripple & noise(*3)(*4)	Vpp	<1800mV	<288mV	<270mV	<288mV	<315mV
	Vrms	<395mV	<23mV	<36mV	<50mV	<63mV
Full load up	<30ms					
Full load down	<80ms					
No load down	<6s	<5s	<10s	<10s	<5s	<6s
Transient Response	<1.5ms					
Remote Compensation	5V					
<b>Constant Current</b>						
Rated value	0~23A	0~540A	0~180A	0~126A	0~90A	0~69A
Settable range	0~24.15A	0~567A	0~189A	0~132.3A	0~94.5A	0~72.45A
Over current protection (OCP)	0%~110% of rated output current					
Current @ Max. Voltage	7.69A	187.5A	60A	42.84A	30A	23.07A
Programming resolution	5 digits					
Programming accuracy(*2)	±0.2% of rated current					
Meter resolution	5 digits					
Meter accuracy(*2)	± 0.2% of rated current					
Line regulation(*6)	±0.05% of rated current					
Load regulation(*7)	±0.15% of rated current					
Temperature coefficient for set values	100ppm/°C of rated output voltage, after a 30 minutes warm-up					
Ripple & noise(*3)(*4)	Arms	20mA	216mA	60mA	45mA	44mA
<b>Constant Power</b>						
Rated value	0~10kW	0~15kW	0~15kW	0~15kW	0~15kW	0~15kW
Settable range	0~10200W	0~15300W	0~15300W	0~15300W	0~15300W	0~15300W
Over power protection (OPP)	0%~110% of rated output current					
Programming resolution	5 digits					
Programming accuracy	< 1% of rated power					
Meter resolution	5 digits					
Meter accuracy(*2)	± 0.5% of rated power					
Line regulation(*6)	< 0.05% of rated power					
Load regulation(*7)	< 0.75% of rated power					
<b>Internal resistance (*9)</b>						
Adjustment range	0~56.521Ω	0~0.1481Ω	0~1.3889Ω	0~2.7778Ω	0~5.5556Ω	0~9.4203Ω
Programming resolution	0.001Ω	0.0001Ω	0.0001Ω	0.0001Ω	0.0001Ω	0.0001Ω
Programming Accuracy(*2)	≤2.3% of max. resistance					
<b>Input</b>						
Nominal input rating	200~415V 50Hz/60Hz 3-phase 3 wires , Optional 480V 50/60Hz 3-phase 4 wires					
Input voltage range	180~460VAC , Optional 480VAC type:432~528VAC					
Input frequency range	47Hz~63Hz					
Current (Maximum)(Input 3P 180V)	40A/phase	60A/phase	60A/phase	60A/phase	60A/phase	60A/phase
Inrush current(Input 3P 460V)	66A/phase	99A/phase	99A/phase	99A/phase	99A/phase	99A/phase
Input Power (Maximum)	12kVA	18kVA	18kVA	18kVA	18kVA	18kVA
Efficiency	86~95% varies by model(*1)					
Leakage current	< 3.5 mA					
Power Factor	0.99 typ.(480V input) / 0.95 typ.(200-415V input)					
<b>Insulation</b>						
Primary - Chassis	DC 2500V					
Primary - Secondary	DC 2500V					
Secondary - Chassis	DC2000V	DC750V	DC750V	DC750V	DC1000V	DC1500V
<b>Weights and dimensions</b>						
Dimensions(WxHxD)	Enclosure : 440 x 129 x 660 mm , Total : 482 x 132 x 765.1 mm					
Weight (kg)	34.8	45.1	43.6	43.6	43.6	43.6

## 15kW Specifications

Rated Power		15kW	15kW	15kW	15kW		
Model number		DSP750-60W□□	DSP1050-42W□□	DSP1500-30W□□	DSP1950-23W□□		
Rated Voltage		750V	1050V	1500V	1950V		
Rated Current		60A	42A	30A	23A		
<b>Constant Voltage</b>							
Rated value		0~750V	0~1050V	0~1500V	0~1950V		
Settable range		0~787.5V	0~1102.5V	0~1575V	0~2047.5V		
Over voltage protection (OVP)		0%~110% of rated output voltage					
Voltage @ Max. Current		250V	357.14V	500V	650V		
Programming resolution		5 digits					
Programming accuracy(*2)		±0.1% of rated voltage					
Meter resolution		5 digits					
Meter accuracy(*2)		± 0.1% of rated voltage					
Line regulation(*6)		±0.02% of rated voltage (with local sense)					
Load regulation(*7)		±0.05% of rated voltage (with local sense)					
Temperature coefficient for set values		100ppm/°C of rated output voltage, after a 30 minutes warm-up					
Ripple & noise(*3)(*4)	Vpp	<830mV	<1440mV	<2160mV	<2160mV		
	Vrms	<196mV	<315mV	<360mV	<510mV		
Full load up		<30ms					
Full load down		<80ms					
No load down		<10s	<10s	<6s	<6s		
Transient Response		<1.5ms					
Remote Compensation		5V					
<b>Constant Current</b>							
Rated value		0~60A	0~42A	0~30A	0~23A		
Settable range		0~63A	0~44.1A	0~31.5A	0~24.15A		
Over current protection (OCP)		0%~110% of rated output current					
Current @ Max. Voltage		20A	14.29A	10A	7.69A		
Programming resolution		5 digits					
Programming accuracy(*2)		±0.2% of rated current					
Meter resolution		5 digits					
Meter accuracy(*2)		± 0.2% of rated current					
Line regulation(*6)		±0.05% of rated current					
Load regulation(*7)		±0.15% of rated current					
Temperature coefficient for set values		100ppm/°C of rated output voltage, after a 30 minutes warm-up					
Ripple & noise(*3)(*4)	Arms	40mA	32mA	24mA	44mA		
<b>Constant Power</b>							
Rated value		0~15kW	0~15kW	0~15kW	0~15kW		
Settable range		0~15300W	0~15300W	0~15300W	0~15300W		
Over power protection (OPP)		0%~110% of rated output current					
Programming resolution		5 digits					
Programming accuracy		< 1% of rated power					
Meter resolution		5 digits					
Meter accuracy(*2)		± 0.5% of rated power					
Line regulation(*6)		< 0.05% of rated power					
Load regulation(*7)		< 0.75% of rated power					
<b>Internal resistance (*9)</b>							
Adjustment range		0~12.500Ω	0~25.000Ω	0~50.000Ω	0~84.782Ω		
Programming resolution		0.001Ω	0.001Ω	0.001Ω	0.001Ω		
Programming Accuracy(*2)		≤2.3% of max. resistance					
<b>Input</b>							
Nominal input rating		200~415V 50Hz/60Hz 3-phase 3 wires , Optional 480V 50/60Hz 3-phase 4 wires					
Input voltage range		180~460VAC , Optional 480VAC type:432~528VAC					
Input frequency range		47Hz~63Hz					
Current (Maximum)(Input 3P 180V)		60A/phase	60A/phase	60A/phase	60A/phase		
Inrush current(Input 3P 460V)		99A/phase	99A/phase	99A/phase	99A/phase		
Input Power (Maximum)		18kVA	18kVA	18kVA	18kVA		
Efficiency		86~95% varies by model(*1)					
Leakage current		< 3.5 mA					
Power Factor		0.99 typ.(480V input) / 0.95 typ.(200-415V input)					
<b>Insulation</b>							
Primary - Chassis		DC 2500V					
Primary - Secondary		DC 2500V					
Secondary - Chassis		DC1500V	DC1500V	DC1500V	DC3000V		
<b>Weights and dimensions</b>							
Dimensions(WxHxD)		Enclosure : 440 x 129 x 660 mm , Total : 482 x 132 x 765.1 mm					
Weight (kg)		43.6	43.6	43.6	43.6		



## 6kW ~ 12kW Specifications

Rated Power	6kW	6kW	12kW	12kW	12kW	12kW
Model number	DSP500-36W□□	DSP650-27W□□	DSP500-72W□□	DSP650-54W□□	DSP1000-30W□□	DSP1300-27W□□
Rated Voltage	500V	650V	500V	650V	1000V	1300V
Rated Current	36A	27A	72A	54A	30A	27A
<b>Constant Voltage</b>						
Rated value	0~500V	0~650V	0~500V	0~650V	0~1000V	0~1300V
Settable range	0~525V	0~682.5V	0~525V	0~682.5V	0~1050V	0~1365V
Over voltage protection (OVP)	0%~110% of rated output voltage					
Voltage @ Max. Current	166.66V	222.22V	166.66V	222.22V	333.33V	444.44V
Programming resolution	5 digits					
Programming accuracy(*2)	±0.1% of rated voltage					
Meter resolution	5 digits					
Meter accuracy(*2)	± 0.1% of rated voltage					
Line regulation(*6)	±0.02% of rated voltage (with local sense)					
Load regulation(*7)	±0.05% of rated voltage (with local sense)					
Temperature coefficient for set values	100ppm/°C of rated output voltage, after a 30 minutes warm-up					
Ripple & noise(*3)(*4)	Vpp	<375mV	<864mV	<375mV	<864mV	<1725mV
	Vrms	<75mV	<216mV	<75mV	<216mV	<376mV
Full load up	<30ms					
Full load down	<80ms					
No load down	<5s	<6s	<5s	<6s	<5s	<6s
Transient Response	<1.5ms					
Remote Compensation	5V					
<b>Constant Current</b>						
Rated value	0~36A	0~27A	0~72A	0~54A	0~36A	0~27A
Settable range	0~37.8A	0~28.35A	0~75.6A	0~56.7A	0~37.8A	0~28.35A
Over current protection (OCP)	0%~110% of rated output current					
Current @ Max. Voltage	12A	9.23A	24A	18.46A	12A	9.23A
Programming resolution	5 digits					
Programming accuracy(*2)	±0.2% of rated current					
Meter resolution	5 digits					
Meter accuracy(*2)	± 0.2% of rated current					
Line regulation(*6)	±0.05% of rated current					
Load regulation(*7)	±0.15% of rated current					
Temperature coefficient for set values	100ppm/°C of rated output voltage, after a 30 minutes warm-up					
Ripple & noise(*3)(*4)	Arms	18mA	18mA	35mA	35mA	24mA
<b>Constant Power</b>						
Rated value	0~6kW	0~6kW	0~12kW	0~12kW	0~12kW	0~12kW
Settable range	0~6120W	0~6120W	0~12240W	0~12240W	0~12240W	0~12240W
Over power protection (OPP)	0%~110% of rated output current					
Programming resolution	5 digits					
Programming accuracy	< 1% of rated power					
Meter resolution	5 digits					
Meter accuracy(*2)	± 0.5% of rated power					
Line regulation(*6)	< 0.05% of rated power					
Load regulation(*7)	< 0.75% of rated power					
<b>Internal resistance (*9)</b>						
Adjustment range	0~13.888Ω	0~24.074Ω	0~6.9444Ω	0~12.037Ω	0~27.777Ω	0~48.148Ω
Programming resolution	0.001Ω	0.001Ω	0.0001Ω	0.001Ω	0.001Ω	0.001Ω
Programming Accuracy(*2)	≤2.3% of max. resistance					
<b>Input</b>						
Nominal input rating	380~415V 50Hz/60Hz 3-phase 3 wires					
Input voltage range	340~460VAC					
Input frequency range	47Hz~63Hz					
Current (Maximum)(Input 3P 340V)	13A/phase	13A/phase	26A/phase	26A/phase	26A/phase	26A/phase
Inrush current(Input 3P 460V)	33A/phase	33A/phase	66A/phase	66A/phase	66A/phase	66A/phase
Input Power (Maximum)	7.2kVA	7.2kVA	14.4kVA	14.4kVA	12kVA	12kVA
Efficiency	86~95% varies by model(*1)					
Leakage current	< 3.5 mA					
Power Factor	0.95 typ.(380~415V input)					
<b>Insulation</b>						
Primary - Chassis	DC 2500V					
Primary - Secondary	DC 2500V					
Secondary - Chassis	DC1000V	DC1500V	DC1500V	DC1500V	DC1500V	DC2000V
<b>Weights and dimensions</b>						
Dimensions(WxHxD)	Enclosure : 440 x 129 x 660 mm , Total : 482 x 132 x 765.1 mm					
Weight (kg)	26	26	34.8	34.8	34.8	34.8

## 18kW Specifications

Rated Power	18kW	18kW	18kW	18kW		
Model number	DSP500-108W□□	DSP650-81W□□	DSP1500-36W□□	DSP1950-27W□□		
Rated Voltage	500V	650V	1500V	1950V		
Rated Current	108A	81A	36A	27A		
<b>Constant Voltage</b>						
Rated value	0~500V	0~650V	0~1500V	0~1950V		
Settable range	0~525V	0~682.5V	0~1575V	0~2047.5V		
Over voltage protection (OVP)	0%~110% of rated output voltage					
Voltage @ Max. Current	166.66V	222.22V	500V	666.66V		
Programming resolution	5 digits					
Programming accuracy(*2)	±0.1% of rated voltage					
Meter resolution	5 digits					
Meter accuracy(*2)	± 0.1% of rated voltage					
Line regulation(*6)	±0.02% of rated voltage (with local sense)					
Load regulation(*7)	±0.05% of rated voltage (with local sense)					
Temperature coefficient for set values	100ppm/°C of rated output voltage, after a 30 minutes warm-up					
Ripple & noise(*3)(*4)	Vpp	<375mV	<864mV	<2590mV	<3360mV	
	Vrms	<75mV	<216mV	<430mV	<645mV	
Full load up	<30ms					
Full load down	<80ms					
No load down	<5s	<6s	<6s	<6s		
Transient Response	<1.5ms					
Remote Compensation	5V					
<b>Constant Current</b>						
Rated value	0~108A	0~81A	0~36A	0~27A		
Settable range	0~113.4A	0~85.05A	0~37.8A	0~28.35A		
Over current protection (OCP)	0%~110% of rated output current					
Current @ Max. Voltage	36A	27.69A	12A	9.23A		
Programming resolution	5 digits					
Programming accuracy(*2)	±0.2% of rated current					
Meter resolution	5 digits					
Meter accuracy(*2)	± 0.2% of rated current					
Line regulation(*6)	±0.05% of rated current					
Load regulation(*7)	±0.15% of rated current					
Temperature coefficient for set values	100ppm/°C of rated output voltage, after a 30 minutes warm-up					
Ripple & noise(*3)(*4)	Arms	54mA	50mA	42mA	42mA	
<b>Constant Power</b>						
Rated value	0~18kW	0~18kW	0~18kW	0~18kW		
Settable range	0~18360W	0~18360W	0~18360W	0~18360W		
Over power protection (OPP)	0%~110% of rated output current					
Programming resolution	5 digits					
Programming accuracy	< 1% of rated power					
Meter resolution	5 digits					
Meter accuracy(*2)	± 0.5% of rated power					
Line regulation(*6)	< 0.05% of rated power					
Load regulation(*7)	< 0.75% of rated power					
<b>Internal resistance (*9)</b>						
Adjustment range	0~4.6296Ω	0~8.0246Ω	0~41.666Ω	0~72.222Ω		
Programming resolution	0.0001Ω	0.0001Ω	0.001Ω	0.001Ω		
Programming Accuracy(*2)	≤2.3% of max. resistance					
<b>Input</b>						
Nominal input rating	380~415V 50Hz/60Hz 3-phase 3 wires					
Input voltage range	340~460VAC					
Input frequency range	47Hz~63Hz					
Current (Maximum)(Input 3P 340V)	40A/phase	40A/phase	40A/phase	40A/phase		
Inrush current(Input 3P 460V)	99A/phase	99A/phase	99A/phase	99A/phase		
Input Power (Maximum)	18kVA	18kVA	18kVA	18kVA		
Efficiency	86~95% varies by model(*1)					
Leakage current	< 3.5 mA					
Power Factor	0.95 typ.(380~415V input)					
<b>Insulation</b>						
Primary - Chassis	DC 2500V					
Primary - Secondary	DC 2500V					
Secondary - Chassis	DC1000V	DC1500V	DC2000V	DC3000V		
<b>Weights and dimensions</b>						
Dimensions(WxHxD)	Enclosure : 440 x 129 x 660 mm , Total : 482 x 132 x 765.1 mm					
Weight (kg)	43.6	43.6	43.6	43.6		

## 10 ~ 15kW(3U) Specifications

Rated Power	10kW	10kW	15kW	15kW	15kW		
Model number	DSP1000-30W□□	DSP1300-23W□□	DSP1050-42W□□	DSP1500-30W□□	DSP1950-23W□□		
Rated Voltage	1000V	1300V	1050V	1500V	1950V		
Rated Current	30A	23A	42A	30A	23A		
<b>Constant Voltage</b>							
Rated value	0~1000V	0~1300V	0~1050V	0~1500V	0~1950V		
Settable range	0~1050V	0~1365V	0~1102.5V	0~1575V	0~2047.5V		
Over voltage protection (OVP)	0%~110% of rated output voltage						
Voltage @ Max. Current	333.33V	434.78V	357.14V	500V	650V		
Programming resolution	5 digits						
Programming accuracy(*2)	±0.1% of rated voltage						
Meter resolution	5 digits						
Meter accuracy(*2)	± 0.1% of rated voltage						
Line regulation(*6)	±0.02% of rated voltage (with local sense)						
Load regulation(*7)	±0.05% of rated voltage (with local sense)						
Temperature coefficient for set values	100ppm/°C of rated output voltage, after a 30 minutes warm-up						
Ripple & noise(*3)(*4)	Vpp	<1440mV	<1800mV	<1440mV	<2160mV	<2160mV	
	Vrms	<315mV	<395mV	<315mV	<360mV	<510mV	
Full load up	<30ms						
Full load down	<80ms						
No load down	<10s	<6s	<10s	<6s	<6s		
Transient Response	<1.5ms						
Remote Compensation	5V						
<b>Constant Current</b>							
Rated value	0~30A	0~23A	0~42A	0~30A	0~23A		
Settable range	0~31.5A	0~24.15A	0~44.1A	0~31.5A	0~24.15A		
Over current protection (OCP)	0%~110% of rated output current						
Current @ Max. Voltage	10A	7.69A	14.29A	10A	7.69A		
Programming resolution	5 digits						
Programming accuracy(*2)	±0.2% of rated current						
Meter resolution	5 digits						
Meter accuracy(*2)	± 0.2% of rated current						
Line regulation(*6)	±0.05% of rated current						
Load regulation(*7)	±0.15% of rated current						
Temperature coefficient for set values	100ppm/°C of rated output voltage, after a 30 minutes warm-up						
Ripple & noise(*3)(*4)	Arms	20mA	20mA	32mA	24mA	44mA	
<b>Constant Power</b>							
Rated value	0~10kW	0~10kW	0~15kW	0~15kW	0~15kW		
Settable range	0~10200W	0~10200W	0~15300W	0~15300W	0~15300W		
Over power protection (OPP)	0%~110% of rated output current						
Programming resolution	5 digits						
Programming accuracy	< 1% of rated power						
Meter resolution	5 digits						
Meter accuracy(*2)	± 0.5% of rated power						
Line regulation(*6)	< 0.05% of rated power						
Load regulation(*7)	< 0.75% of rated power						
<b>Internal resistance (*9)</b>							
Adjustment range	0~33.333Ω	0~56.521Ω	0~25.000Ω	0~50.000Ω	0~84.782Ω		
Programming resolution	0.001Ω	0.001Ω	0.001Ω	0.001Ω	0.001Ω		
Programming Accuracy(*2)	≤2.3% of max. resistance						
<b>Input</b>							
Nominal input rating	200~415V 50Hz/60Hz 3-phase 3 wires , Optional 480V 50/60Hz 3-phase 4 wires						
Input voltage range	180~460VAC , Optional 480VAC type:432~528VAC						
Input frequency range	47Hz~63Hz						
Current (Maximum)(Input 3P 180V)	40A/phase	40A/phase	60A/phase	60A/phase	60A/phase		
Inrush current(Input 3P 460V)	66A/phase	66A/phase	99A/phase	99A/phase	99A/phase		
Input Power (Maximum)	12kVA	12kVA	18kVA	18kVA	18kVA		
Efficiency	86~95% varies by model(*1)						
Leakage current	< 3.5 mA						
Power Factor	0.99 typ.(480V input) / 0.95 typ.(200-415V input)						
<b>Insulation</b>							
Primary - Chassis	DC 2500V						
Primary - Secondary	DC 2500V						
Secondary - Chassis	DC1500V	DC2000V	DC1500V	DC1500V	DC3000V		
<b>Weights and dimensions</b>							
Dimensions(WxHxD)	Enclosure : 440 x 129 x 660 mm , Total : 482 x 132 x 765.1 mm						
Weight (kg)	34.8	34.8	43.6	43.6	43.6		

## 12 ~ 18kW(3U) Specifications

Rated Power	12kW	12kW	18kW	18kW		
Model number	DSP1000-30W□□	DSP1300-27W□□	DSP1500-36W□□	DSP1950-27W□□		
Rated Voltage	1000V	1300V	1500V	1950V		
Rated Current	30A	27A	36A	27A		
<b>Constant Voltage</b>						
Rated value	0~1000V	0~1300V	0~1500V	0~1950V		
Settable range	0~1050V	0~1365V	0~1575V	0~2047.5V		
Over voltage protection (OVP)	0%~110% of rated output voltage					
Voltage @ Max. Current	333.33V	444.44V	500V	666.66V		
Programming resolution	5 digits					
Programming accuracy(*2)	±0.1% of rated voltage					
Meter resolution	5 digits					
Meter accuracy(*2)	± 0.1% of rated voltage					
Line regulation(*6)	±0.02% of rated voltage (with local sense)					
Load regulation(*7)	±0.05% of rated voltage (with local sense)					
Temperature coefficient for set values	100ppm/°C of rated output voltage, after a 30 minutes warm-up					
Ripple & noise(*3)(*4)	Vpp	<1725mV	<2240mV	<2590mV	<3360mV	
	Vrms	<376mV	<490mV	<430mV	<645mV	
Full load up	<30ms					
Full load down	<80ms					
No load down	<5s	<6s	<6s	<6s		
Transient Response	<1.5ms					
Remote Compensation	5V					
<b>Constant Current</b>						
Rated value	0~36A	0~27A	0~36A	0~27A		
Settable range	0~37.8A	0~28.35A	0~37.8A	0~28.35A		
Over current protection (OCP)	0%~110% of rated output current					
Current @ Max. Voltage	12A	9.23A	12A	9.23A		
Programming resolution	5 digits					
Programming accuracy(*2)	±0.2% of rated current					
Meter resolution	5 digits					
Meter accuracy(*2)	± 0.2% of rated current					
Line regulation(*6)	±0.05% of rated current					
Load regulation(*7)	±0.15% of rated current					
Temperature coefficient for set values	100ppm/°C of rated output voltage, after a 30 minutes warm-up					
Ripple & noise(*3)(*4)	Arms	24mA	24mA	42mA	42mA	
<b>Constant Power</b>						
Rated value	0~12kW	0~12kW	0~18kW	0~18kW		
Settable range	0~12240W	0~12240W	0~18360W	0~18360W		
Over power protection (OPP)	0%~110% of rated output current					
Programming resolution	5 digits					
Programming accuracy	< 1% of rated power					
Meter resolution	5 digits					
Meter accuracy(*2)	± 0.5% of rated power					
Line regulation(*6)	< 0.05% of rated power					
Load regulation(*7)	< 0.75% of rated power					
<b>Internal resistance (*9)</b>						
Adjustment range	0~27.777Ω	0~48.148Ω	0~41.666Ω	0~72.222Ω		
Programming resolution	0.001Ω	0.001Ω	0.001Ω	0.001Ω		
Programming Accuracy(*2)	≤2.3% of max. resistance					
<b>Input</b>						
Nominal input rating	380~415V 50Hz/60Hz 3-phase 3 wires					
Input voltage range	340~460VAC					
Input frequency range	47Hz~63Hz					
Current (Maximum)(Input 3P 180V)	26A/phase	26A/phase	40A/phase	40A/phase		
Inrush current(Input 3P 460V)	66A/phase	66A/phase	99A/phase	99A/phase		
Input Power (Maximum)	12kVA	12kVA	18kVA	18kVA		
Efficiency	86~95% varies by model(*1)					
Leakage current	< 3.5 mA					
Power Factor	0.95 typ.(380~415V input)					
<b>Insulation</b>						
Primary - Chassis	DC 2500V					
Primary - Secondary	DC 2500V					
Secondary - Chassis	DC1500V	DC2000V	DC2000V	DC3000V		
<b>Weights and dimensions</b>						
Dimensions(WxHxD)	Enclosure : 440 x 129 x 660 mm , Total : 482 x 132 x 765.1 mm					
Weight (kg)	34.8	34.8	43.6	43.6		

## General Specifications

Environment	
Operating environment	Indoor use
Operating temperature	0°C ~ 50°C
Operating humidity	30%rh ~ 80%rh (no condensation) ,80% RH at 30°C. Decrease linearly to 50% RH at 40°C
Storage temperature	-20°C ~ 70°C
Storage humidity	10%RH ~ 80%RH (no condensation)
Altitude	Up to 2000m
Cooling	Air cooling with speed controlled fan
Ground polarity	Capable of Negative ground or Positive ground
Memory & Sequence	
Number of memory	3 sets (operating in front panel)
Maximum steps	500 steps per Sequence
Maximum number of sequence	16
Adjustable time range	0.00 sec ~ 999999.99 sec
Standard Interface	
LAN interfaces	1 x LXI 1.4 for communication
Digital I/O	Function : Interlock , External output ON/OFF , Shut OFF , Alarm signal output, Output voltage downward signal
Optional Analog Interface	
Status output (dry contact)	CV , CC , CP (*9) , CR (*9) , ON/OFF
Voltage control	user define 0~5V/0~10V refer to 0~100% of rating output voltage
Voltage control accuracy(*2)	±0.2%
Current control	user define 0~5V/0~10V refer to 0~100% of rating output voltage
Current control accuracy(*2)	±0.2%
Power control(*9)	user define 0~5V/0~10V refer to 0~100% of rating output voltage
Power control accuracy(*2)(*9)	±0.2%
Monitoring output	0~5V or 0~10V output for monitoring V/A/W
Monitoring accuracy (*2)	±2%
Reference output	0~5VDC or 0~10VDC (max=5mA)

- \*1. 0°C ~ 50°C ambient temperature after 30 mins warm.  
Humidity: Under 80% RH, with 2%~100% of rated voltage, 1%~100% of rated current, measured at the output terminals with local sensing.
- \*2. At 23°C ± 5°C
- \*3. Ripple and Noise (rms value) Measurement bandwidth up to 300 kHz
- \*4. Ripple and Noise (peak value) measurement bandwidth up to 20 MHz
- \*5. Time for output voltage recover to ±1% of rated value when load changes from 10% to 90% (Fig-1)
- \*6. Constant load (0~100%), Input changes between 180 ~ 264VAC or 342 ~ 460VAC
- \*7. CV : Constant Input (Full input range), current changes 10% ~ 90%  
CC : Constant Input (Full input range), voltage changes 10% ~ 100%  
CP : Constant Input (Full input range), voltage x current 10% ~ 90%
- \*8. Output response UP time : Time for output voltage rises from 10% to 90% of rated voltage. (Fig-2)  
Output response Down time : Time for output voltage falls from 90% to 10% of rated voltage.
- \*9. DSP-WE/DSP-WAe series not supported.

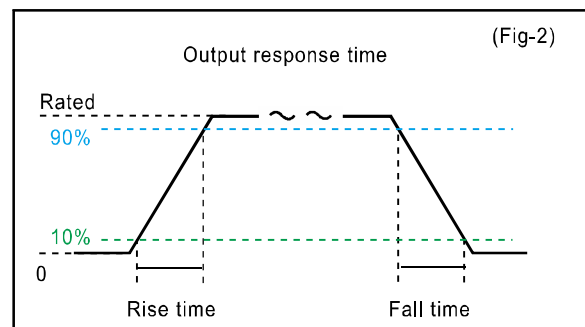
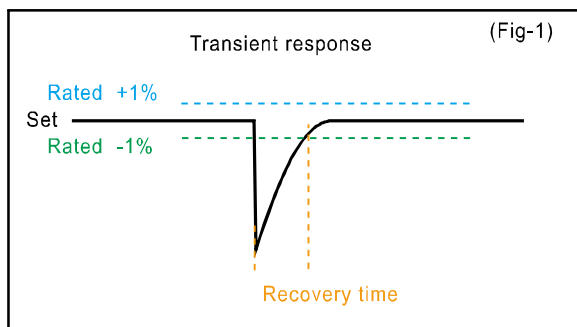

# Programmable Power Distribution Unit series

## PDU10 / PDU6 Programmable Power Distribution Unit

Patented innovational design and functions, equipped with digital controller, protection, remote, measurement and multiple connection in parallel, it sequentially controls and secures AC mains supply to the DC power supplies and provides useful CO<sub>2</sub>e and efficiency readings.

Last the eco-friendly principle, PDU series remains stainless steel chassis; no plating and very few painting, state-of-the-art functions help you manage million power easily as well as environment protection.

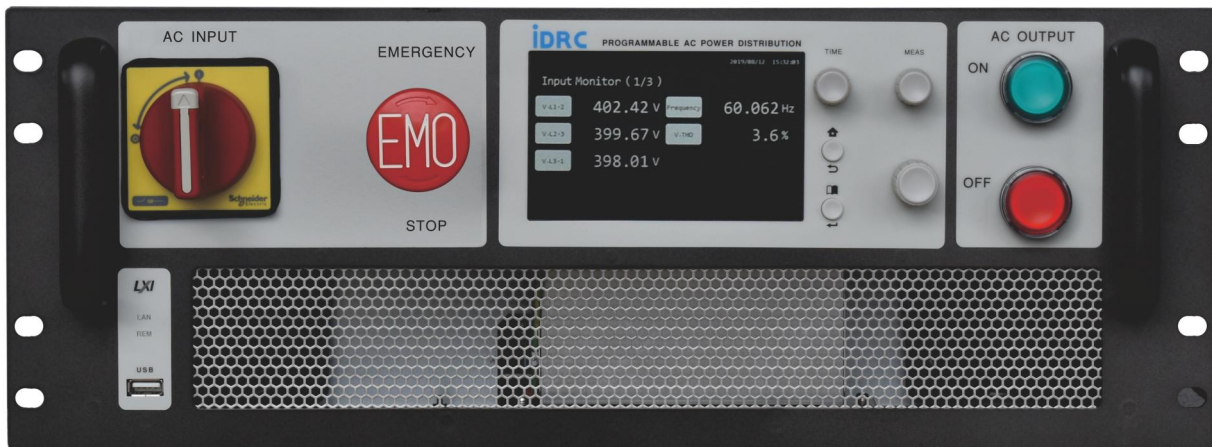

## World First Innovation

- PDU10/PDU6, 4U height, connect with 10/6 units 18kW iDRC DC power supply.
- Master-slave function, control millions watt DC power via single LAN cable.
- 5" 800x480 WVGA+touchscreen associate with knobs and buttons to form an intuitive human interface.
- Built-in AC mains monitoring system, it provides ten and up needful parameters such as V, A, Freq, VA, Watt, VAR, kWh, CO<sub>2</sub>e and Efficiency.
- Two accumulators inside permanent and resettable.
- CE approved.
- LXI 1.5 approved

## Electrical

- 3Ø180~460VAC, 47~63Hz Universal Input.
- Embedded system with multiple 32 bit ARM based MCU, fast boot time of 10 seconds or less.
- Built-in Timer, allows to set output running time.
- Built-in RTC, time remain reliable without a time server.
- Close case firmware upgrading, enhance protection to prevent upgrade failure.
- Full remote control via a single LAN cable.
- Definable power on number of slaves, off the surplus units to save energy.
- Easy to replace individual output terminal.

## ○ Safety

---

- SEMATECH std. EMO button- physically off all managed DC power supplies at once.
- Distinct AC output On/Off button, sequence On/Off DC power supplies.
- Lockable power switch to avoid accidental operation.
- Interlock function.

## ○ Interface

---

- Built-in 2 LAN(LXI) ports, saves the cost of an extra switch hub.
- Fast LAN response time of 3ms.
- SCPI compatible
- Alarm signal output and interlock mechanism prevent potential injury.
- Support USB plug and play, easy to store and read data.

## PDU2 Power Distribution Unit

Economic Design for sequential on or off of 2 slaves.

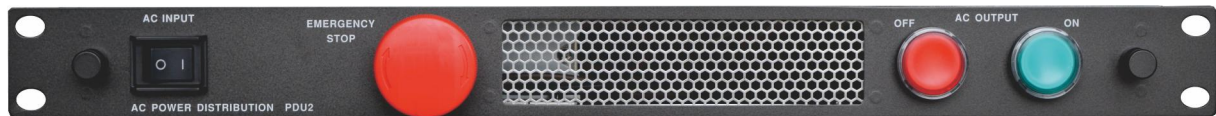

## ○ World First Innovation

---

- PDU2, 1U height, control 2 units 18kW iDRC DC power supply.
- MAX power rate at 36KW
- CE approved

## ○ Electrical

---

- 3Ø180~460VAC, 47~63Hz universal Input
- Sequential power ON/OFF.
- Easy to replace output terminal.

## ○ Safety

---

- SEMATECH std. EMO button, physically off all managed DC power supply at once.
- Distinct AC Output On/Off button to On/Off DC power supply in sequence..

note.: \*1. The format of USB flash drive should be FAT16(2GB) or FAT32(32GB) USB2.0

# Functions and Displays of PDU10/PDU6

PDU10/PDU6 provide various readings in different pages.

Turn MEAS knob to switch between pages

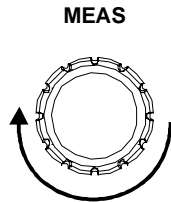

MSD 2017/08/03 08:00:42

Input Monitor ( 1/3 )

V-L1-2	400.02 V	Frequency	60.00 Hz
V-L2-3	400.89 V	V-THD	0.1 %
V-L3-1	398.80 V		

MSD 2017/08/03 08:01:04

Output Measure 1 ( 2/3 )

V-L1-2	400.06 V	Curr-L1	397.86 A
V-L2-3	400.88 V	Curr-L2	401.97 A
V-L3-1	398.74 V	Curr-L3	399.81 A
V-L-L	399.89 V	Curr-Sum	1199.64 A

MSD 2017/08/03 08:01:10

Output Measure 2 ( 3/3 )

V-L-L	399.88 V	P	276.977 kW
Curr-Sum	1199.62 A	S	276.980 kVA
V-THD	0.0 %	PF	0.999
Curr-THD	0.0 %	Effi.	0.0 %

Dedicated TIME knob for all time related parameters adjustment

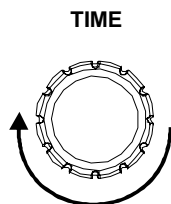

MSD 2017/08/03 08:01:16

Watt Hour ( 1/3 )

Wh	0.0 kWh
INT Time	0.0 Sec

Start Stop Reset

MSD 2017/08/03 08:01:21

CO2 Emissions ( 2/3 )

CO2 Rate	276.962 kg/h
Total CO2	0.00000 t
Coefficient	1.000 kg/kWh

Start Stop Reset

MSD 2017/08/03 08:12:12

Output Time ( 3/3 )

Output On at	2017/08/03 08:11:48
Output Off In	0.0 Sec



## Web Server Function

PDU10/PDU6 provide web GUI function, it allows user to control the DC power system via ethernet.

Instrument Welcome Page	
Device Model	PDU10
Manufacturer	IDRC
Serial Number	000000
Description	PDU10_000000
LXI Extended Features	LXI HSLIP
LXI Version	1.4 LXI Device Specification 2011
Hostname	PDU10_000000.local
MAC Address	70:46:42:8C:65:F1
TCP/IP Address	192.168.42.203
Firmware Revision	0.36.00
Instrument Address String	TCPIP0::192.168.42.203::5025::SOCKET TCPIP0::192.168.42.203::HSLIP0::INSTR
Device Indicator	Inactive <input type="button" value="Toggle"/>

<Web server information>

Output	OFF	
Integrate	OFF	
Freq:	60.00	Hz
U <sub>12</sub> :	400.19	V
U <sub>23</sub> :	401.01	V
U <sub>31</sub> :	398.83	V
THD <sub>U</sub> :	0.1	%
I <sub>1</sub> :	397.95	A
I <sub>2</sub> :	402.18	A
I <sub>3</sub> :	399.80	A
THD <sub>I</sub> :	0.1	%
P:	277.134	kW
S:	277.137	kVA
PF:	1.000	
Effi:	0.0	%
WH:	0.0	kWh
Int. time:	0	Sec
CO <sub>2</sub> Rate:	277.133	kg/h
Total CO <sub>2</sub> :	0.00000	t
Off in:		

<Parameters>

## PDU Application Example

Patented innovative Power Distribution Unit series consolidate microprocessor and management of two hundred thousand VA AC mains in a 4U height chassis. It significantly simplifies the control and wiring for a 180kW DC Power System.

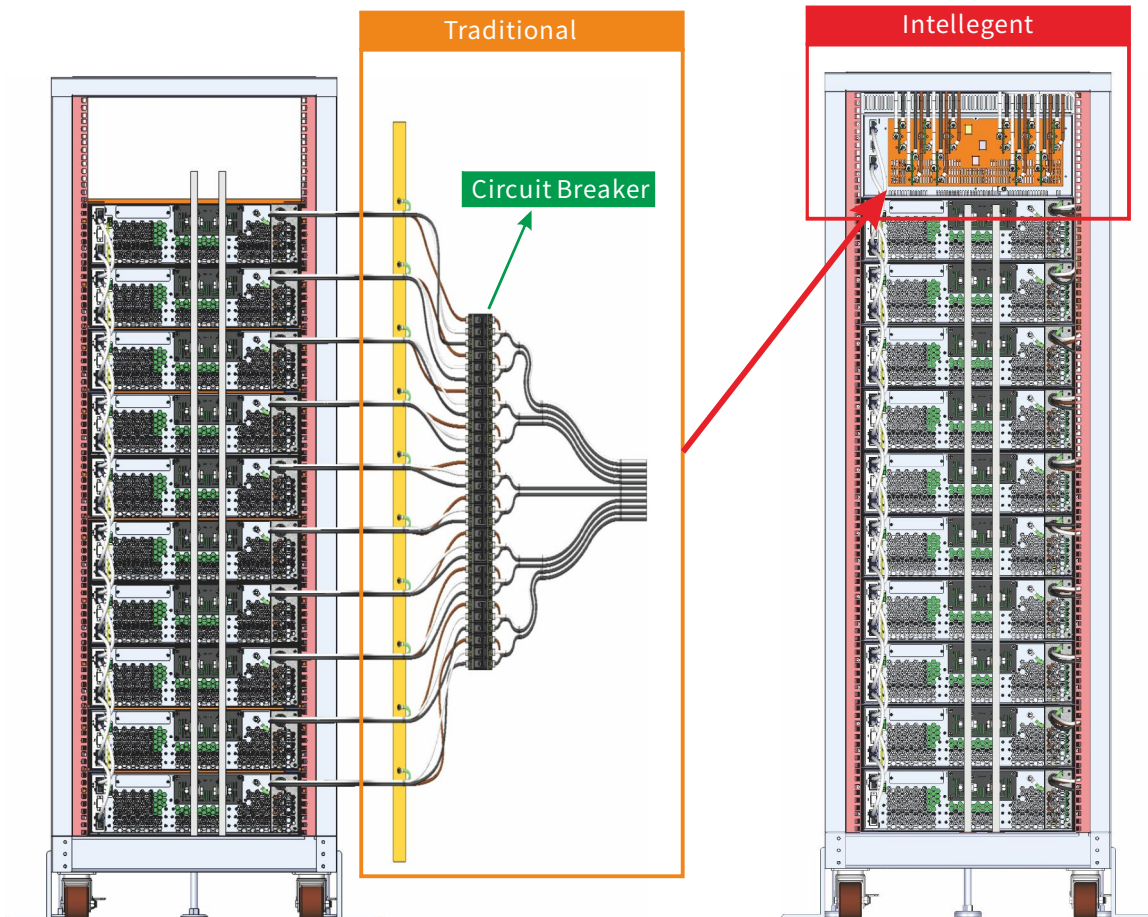

## PDU Series Specifications

Model number	PDU10	PDU6	PDU2
Control unit	1~10	1~6	1~2
<b>Input &amp; Output Specification</b>			
Input Voltage range	180~460VAC , Optional 480VAC type:432~528VAC		
Nominal voltage	200/208/220/380/400/415VAC		
Phase/Wires	3-phase / 3 wires		
Frequency range	45Hz ~ 65Hz		
Max Current(at 180V 3-phase)	600A	360A	120A
Max Power	180kVA	108kVA	36kVA
<b>System settings</b>			
Nominal voltage	Selectable 200/208/220/380/400/415VAC		-
Frequency	Selectable 50Hz/60Hz		-
Power OFF timer	DDD/HH/MM		-
Number of Interlock I/O	1~3		-
CO <sub>2</sub> emission coefficient	0.000kg/kWh ~ 9.999 kg/kWh		-
<b>Sequential Control settings</b>			
Power ON sequence	The power ON order is from the last Slave unit to the Master unit.		
Power OFF sequence	The power OFF order is from the Master unit to the last Slave unit.		
ON/OFF control	Manual/Timer/Remote		-
<b>Input measurement</b>			
Voltage (L1, L2, L3)	Range	600V / 300V	
	Resolution	0.01V	
	Accuracy	± 0.2%	
Frequency	Resolution	0.001Hz	
	Accuracy	± 0.2%	
<b>Output measurement</b>			
Current (L1, L2, L3)	Range	600A / 300A / 60A	600A / 300A / 60A
	Resolution	0.01A	
	Accuracy	± 0.8%	
Active Power (P)	Resolution	0.001kW	
	Accuracy	± 1.5%	
Apparent Power (S)	Resolution	0.001kVA	
	Accuracy	± 1.5%	
Power Factor	Resolution	0.001	
	Accuracy	± 1%	
Kilo-Watt-Hour	Resolution	0.1 kWh	
	Accuracy	± 1.5%	
CO <sub>2</sub> emission	Real time	0000.000 ~ 9999.999kg	
	Accumulate	0000.0000t ~ 9999.9999t	
Efficiency (DC power supply output/input)	Resolution	0.1%	
	Accuracy	± 1.5%	
Voltage	Resolution	0.1%	
Total Harmonic Distortion	Accuracy	± 1%	
Current	Resolution	0.1	
Total Harmonic Distortion	Accuracy	± 1%	
<b>Safety and Protection</b>			
Emergency Stop	EMS button on the front panel		-
OVP	+10% of Nominal input		-
UVP	-10% of Nominal input		-
OCP	+10% of Max. input current		-
OLP	Adjustable from 18kVA to 180kVA	Adjustable from 18kVA to 108kVA	-
Frequency	± 3Hz at 50Hz/60Hz		-
Phase loss	Alarm and stop operation when lose any phase.		
<b>Status Indication on the LCD display</b>			
REMOTE	REMOTE will show on the LCD display when the PDU is connected to PC		-
KEY LOCK	KEY LOCK will show on the LCD display when the keys are locked		-
Error	ERR will show on the LCD display when any error occurs		-
<b>Digital interface - LAN</b>			
Standard	LXI		
Line ending character	Reception : LF , END ; Transmission : LF+END		
<b>External Control I/O</b>			
EMS	1. Multiple rack cabinet EMS can be connected in series. 2. Extendable EMS switch.		
Interlock	Equipped with three interlock connectors (in series).		-

## PDU Series Specifications

Model number	PDU10	PDU6	PDU2	
Control units	1~10	1~6	1~2	
<b>General specification</b>				
Auxiliary Power Supply	Input voltage	180~460VAC ,Optional 480VAC for 15kW model		
	Frequency	45Hz ~ 65Hz		
	Power consumption	≤55W	≤46W	≤35W
	Standby power	≤30W	≤30W	≤10W
Environmental Condition	Operating environment	Indoor use		
	Operating temperature	0°C ~ 50°C		
	Operating humidity	30%rh ~ 80%rh (no condensation), 80% RH at 30°C , . Decrease linearly to 50% RH at 40°C		
	Storage temperature	-20°C ~ 70°C		
	Storage humidity	10%rh ~ 80%rh (no condensation)		
	Altitude	Up to 2000m		
Withstanding voltage	Cooling method	Forced air cooling		
	Primary - Chassis	DC2500V		
	Primary - Secondary	DC2500V		
Secondary - Chassis	DC2500V			
<b>Physical specification</b>				
Display panel	TFT LCD Touchscreen 127mm(5" - 800x480 )		-	
Dimensions (W x H x D)	440 x 176 x 849.6 mm		-	
Weight	40kg	35kg	12kg	
<b>Accessories</b>				
LAN cable	2m		-	
RS485 cable	1pc (AWG24-2m)		-	

\*1. All parameters are measured after 30 minutes warm-up. Ambient temperature at 23±5°C, Humidity Under 80% RH, AC Voltage : 415V±5%, Frequency : 50/60Hz±5%.

## Rear Panel

### PDU10/PDU6

- ① Master/Slave Port
- ② I/O Port-1
- ③ LAN (LXI) connector
- ④ I/O Port-2
- ⑤ Line In
- ⑥ Line Out
- ⑦ Ground Terminal

### PDU2

- ⑧ Line In
- ⑨ Ground Terminal
- ⑩ I/O Port
- ⑪ Line Out

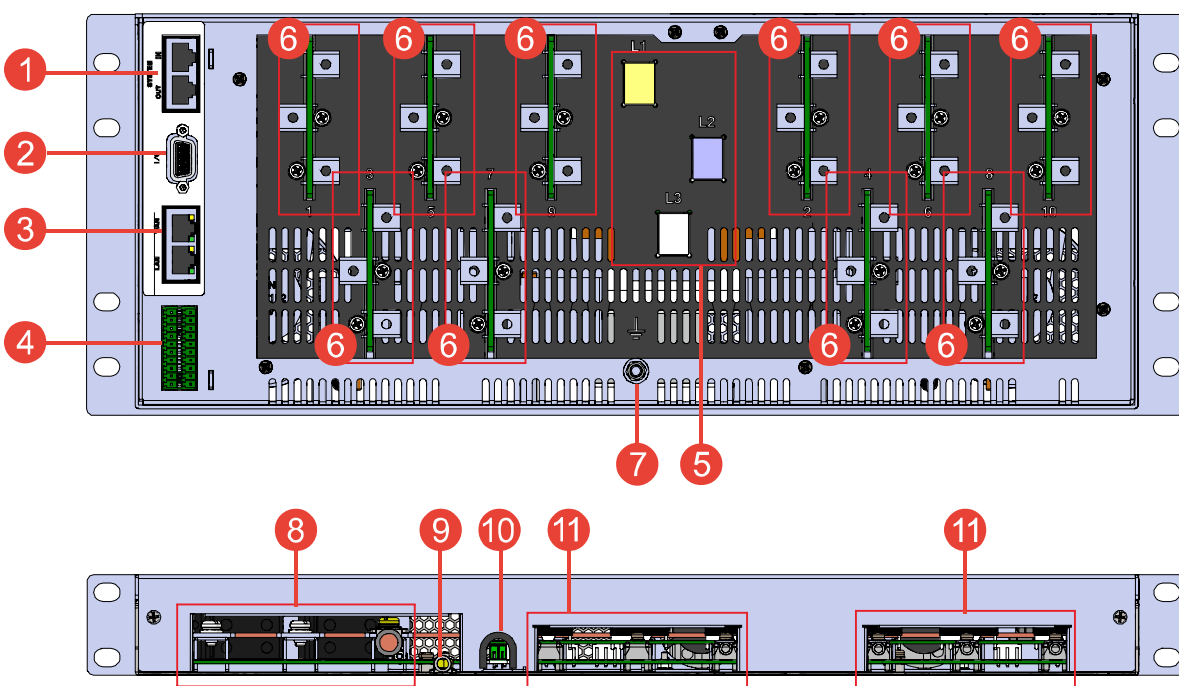

## DC-RACK Series Specifications

- 4 kinds of rack for 150kW / 90kW / 60kW / 30kW (15kW type) or 180kW / 108kW / 72kW / 36kW (18kW type) DSP-Wx wide range DC power supply.
- Professional wiring at factory.
- Standard PDU series handles master/slave control between racks.
- Accessories include anti-tilt stand, inner power cable/copper bar and installation tool kits.

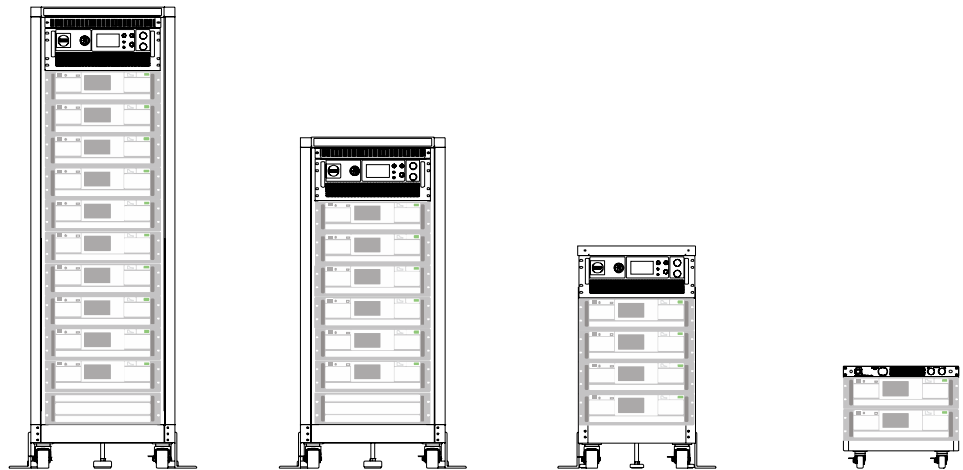

Model number	DC-RACK10	DC-RACK6	DC-RACK4	DC-RACK2
Description	10 unit DSP-Wx in parallel	6 unit DSP-Wx in parallel	4 unit DSP-Wx in parallel	2 unit DSP-Wx in parallel
Height	38U	26U	16U	7U
Model no.	PDU10	PDU6	PDU6	PDU2
Application model	DSP-WR , DSP-WE , DSP-WA , DSP-WAe Series Wide Range Programmable DC Power Supply DSP-WS , DSP-WAs Series Solar Array Simulator			
Capacity	10	6	4	2
Power range	180kW ~ 5kW	108kW ~ 5kW	72kW ~ 5kW	36kW ~ 5kW
Rack Dimension(WxHxD)mm	601 x 1915 x 1000	601 x 1380 x 1000	490 x 932 x 996	482 x 426 x 722
Rack Dimension included stand (WxHxD)mm	783.2 x 1915 x 1035.6	783.2 x 1380 x 1035.6	667.1 x 932 x 1038	482 x 426 x 778

Paralleling **100** units up to **1800kW**

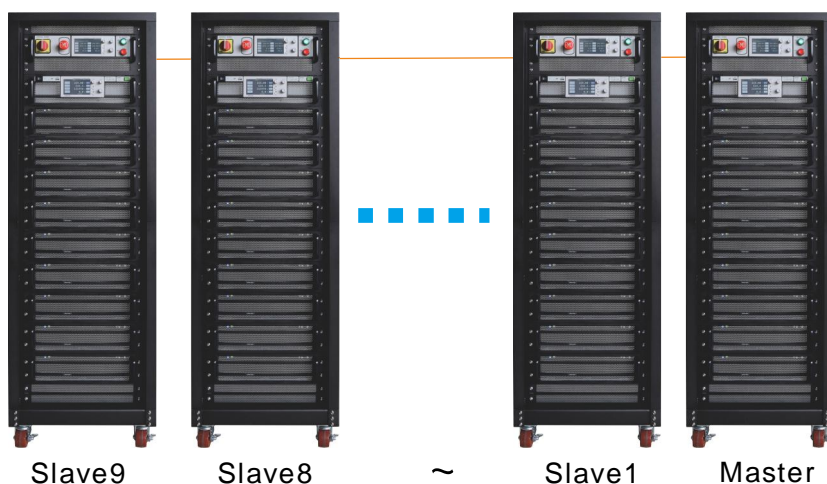

- Unique digital synchronization technique.
- PDU master/slave control capability  
Manage million power via a single Ethernet cable.



# DC-RACK Dimensions (mm)

## DC-RACK10

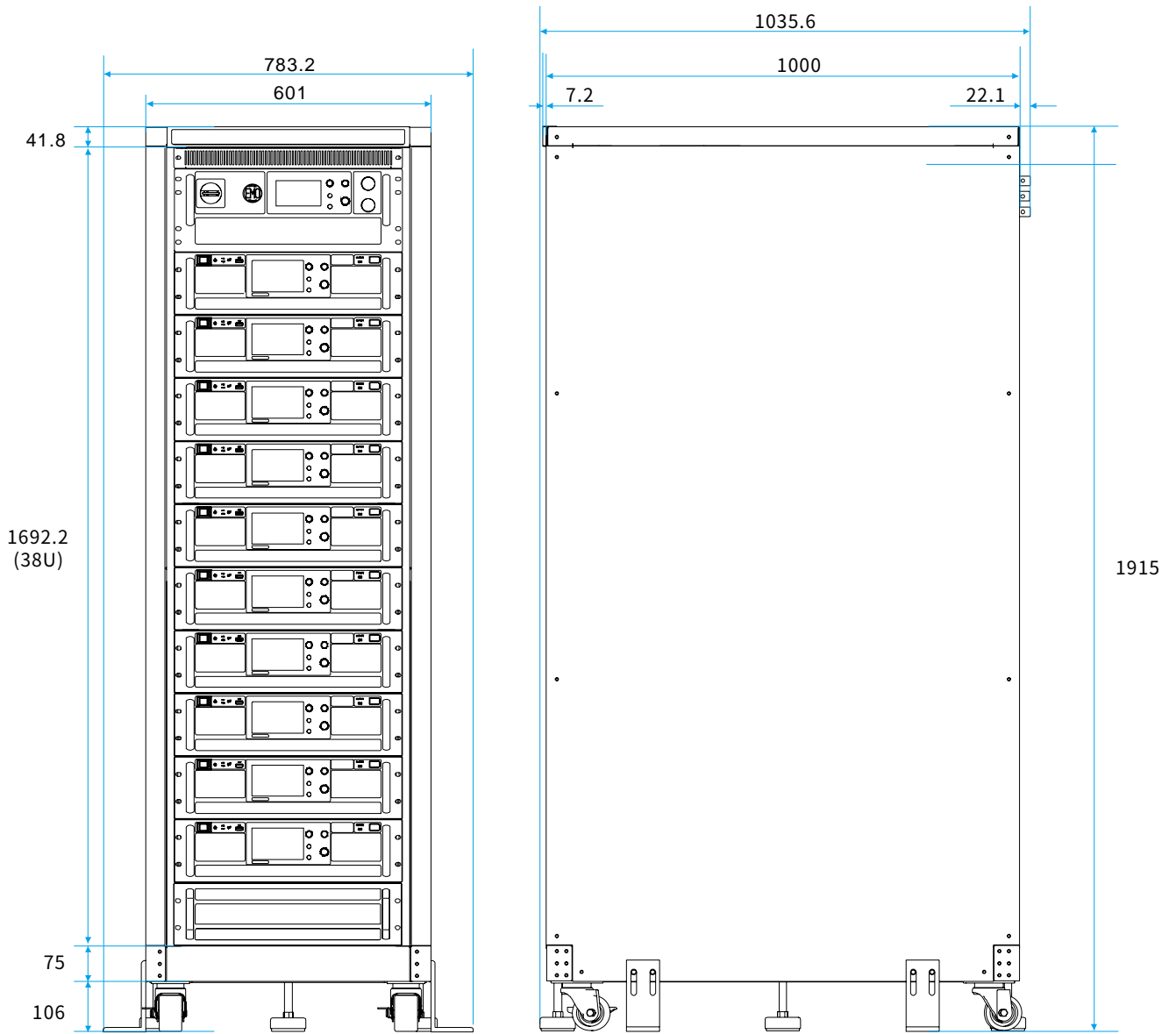

## DC-RACK2

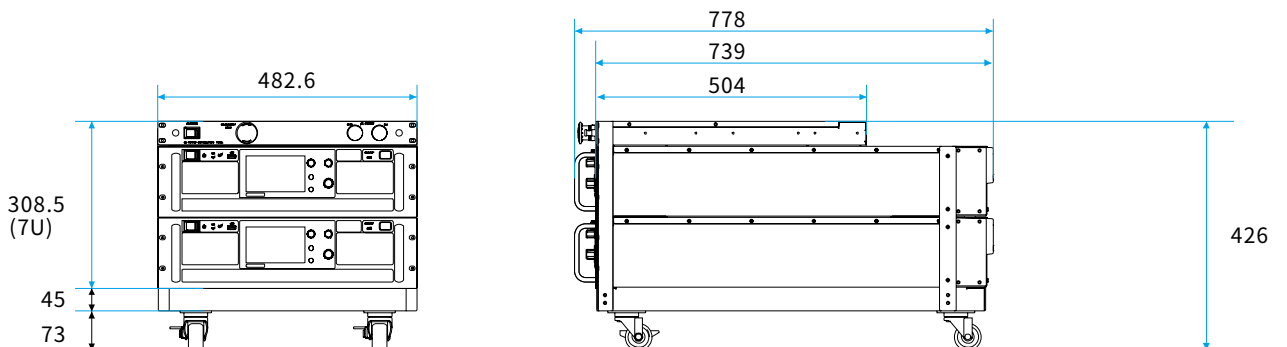

For reference only. May vary slightly on order.

# DC-RACK Dimensions(mm)

## DC-RACK6

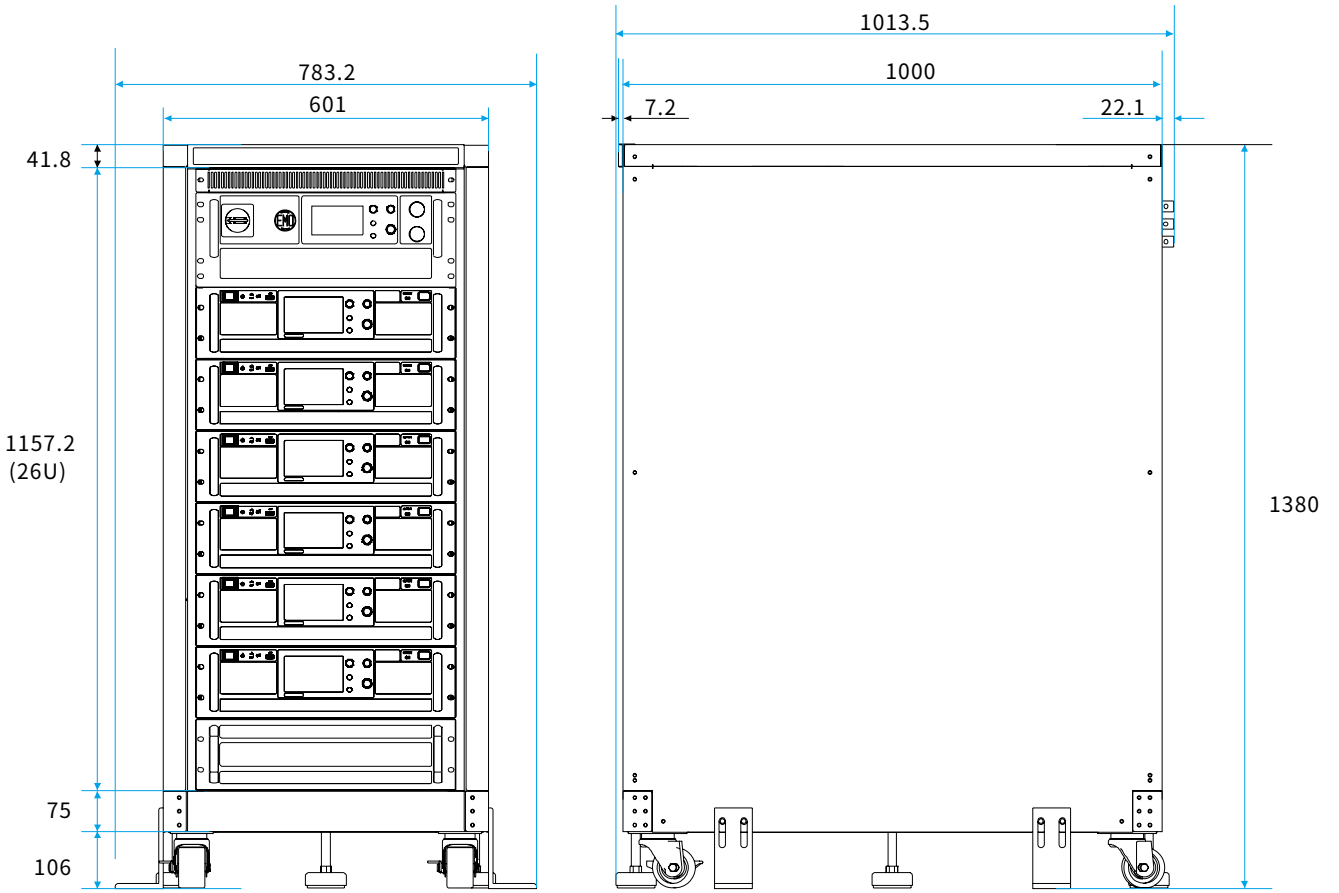

## DC-RACK4

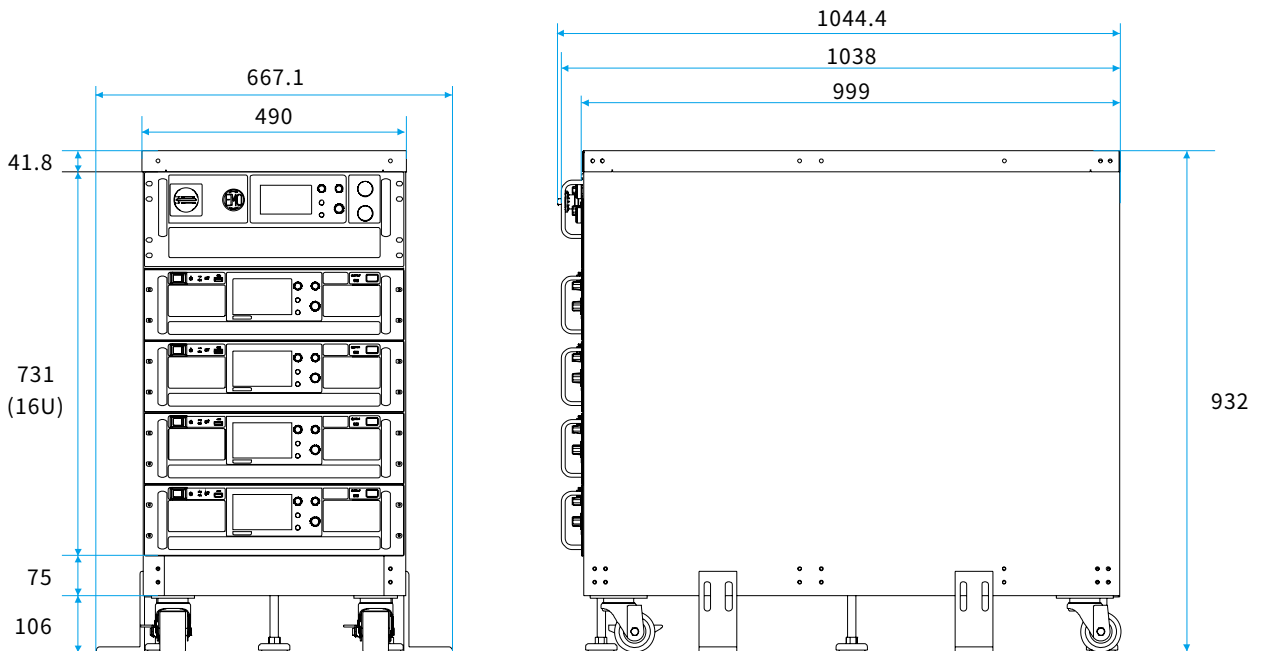

For reference only. May vary slightly on order.

## Quick Reference Charts

Series	DSP-WR	DSP-WS	DSP-WE	DSP-WA	DSP-WAs	DSP-WAe
Symbol	<b>R</b>	<b>S</b>	<b>E</b>	<b>A</b>	<b>As</b>	<b>Ae</b>
Voltage range	80V~1500V	1000V~1500V	80V~1500V	80V~1500V	1000V~1500V	80V~1500V
Models	19	3	19	19	3	19
LCD size	5"	5"	5"	X	X	X
LCD resolution	800x480	800x480	800x480	X	X	X
Output ON priority	CV,CC,CP	CV,CC,CP,I/V	CV,CC	CV,CC,CP	CV,CC,CP,I/V	CV,CC

Function	Models
Touch screen	<b>R</b> <b>S</b> <b>E</b>
Front USB	<b>R</b> <b>S</b> <b>E</b>
CV adjust	<b>R</b> <b>S</b> <b>E</b> <b>A</b> <b>As</b> <b>Ae</b>
CC adjust	<b>R</b> <b>S</b> <b>E</b> <b>A</b> <b>As</b> <b>Ae</b>
CP adjust	<b>R</b> <b>S</b> <b>As</b> <b>A</b>
Internal resistance	<b>R</b> <b>S</b> <b>As</b> <b>A</b>

Function	Models
Operating Mode - Simple mode	<b>R</b> <b>S</b> <b>E</b>
Operating Mode - Complete mode	<b>R</b> <b>S</b> <b>E</b>
Operating Mode - Sequence mode	<b>R</b> <b>S</b> <b>E</b>
Operating Mode - Insertion mode	<b>R</b> <b>S</b> <b>E</b>
Operating Mode - SAS curve	<b>S</b> <b>As</b>
Operating Mode - SAS table	<b>S</b> <b>As</b>
Voltage slew rate	<b>R</b> <b>S</b> <b>E</b> <b>A</b> <b>As</b> <b>Ae</b>
Current slew rate	<b>R</b> <b>S</b> <b>E</b> <b>A</b> <b>As</b> <b>Ae</b>
Power slew rate	<b>R</b> <b>S</b> <b>E</b> <b>A</b> <b>As</b> <b>Ae</b>

## Options

Function	Description
WR-OPT-FUA	Firmware update adapter
WR-OPT-422U	RS-422+RS485+USB interface
WR-OPT-ANA	Isolated Analog Interface
WR-OPT-488	IEEE-488 (GPIB) interface
WR-OPT-ICE	AC Input Cover Assembly+Nylon Cable Gland
WR-OPT-ICN	AC Input board Assembly
WR-OPT-OPC	Output protection cover
WR-OPT-CAB	Parallel cable kit
WR-OPT-2EC	2m Ethernet Cable
WR-OPT-AC480	AC 3Ø4W 480V input (input range AC 432V ~ 528V)
WR-OPT-DC550	DC 500V input (input range DC400V ~ DC600V)
WR-OPT-TOOL	Install tool kit
WR-OPT-PBB	Parallel bus bar(80V 10kW/15kW model only)
WR-OPT-DC	Discharge Circuit(*1)
WR-OPT-CB	Capacitor Bank(*1)
WR-OPT-FD	Freewheeling diode(*1)
WR-OPT-RP	Reverse Protection(*1)
DC-RACK10	37U Rack assembly (include rack,PDU10,AC mains and DC output wiring)
DC-RACK6	25U Rack assembly (include rack,PDU6,AC mains and DC output wiring)
DC-RACK4	16U Rack assembly (include rack,PDU6,AC mains and DC output wiring)
DC-RACK2	7U Rack assembly (include rack,PDU2,AC mains and DC output wiring)

## Options

- ◆ **WR-OPT-ICE**  
AC input cover assembly  
+nylon cable gland



- ◆ **WR-OPT-ICN**  
AC Input board  
Assembly



- ◆ **WR-OPT-TOOL**  
Installation tool kit

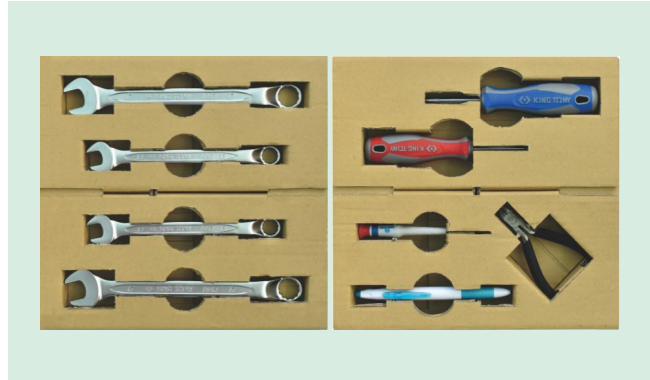

- ◆ **WR-OPT-OPC**  
ABS plastic output  
protection cover



- ◆ **WR-OPT-FUA**  
Firmware update  
adapter



- ◆ **WR-OPT-DC**  
Discharge Circuit

- ◆ **WR-OPT-CB**  
Capacitor Bank

- ◆ **WR-OPT-FD**  
Freewheeling Diode

- ◆ **WR-OPT-RP**  
Reverse Protection

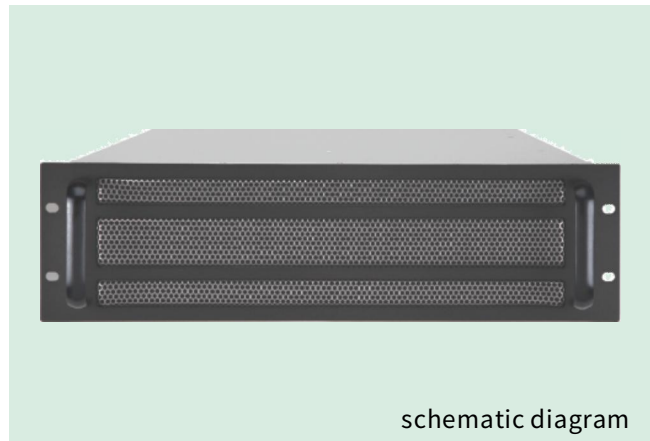

- ◆ **WR-OPT-PBB**  
Parallel bus bar  
(80V model only)



## Ordering Information

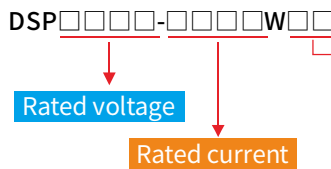

- R : DSP-WR 5" touchscreen, full function models
- E : DSP-WE 5" touchscreen, economic models
- S : DSP-WS 5" touchscreen, Solar array simulator
- A : DSP-WA ATE purposed(CV/CC/CP) or slave unit for DSP-WR
- Ae : DSP-WAe ATE purposed(CV/CC) or slave unit for DSP-WE
- As : DSP-WAs ATE purposed(CV/CC/CP) or slave unit for DSP-WS

## idrc CHYNG HONG ELECTRONIC CO., LTD.

### Taipei Taiwan

4th F, 3-3 Baohong Rd., Hsin Tien District, New Taipei City  
TEL:+886-2-2918-4785 FAX:+886-2-2918-6927

### Taichung Taiwan

No.80, Lane 258, Sec. 3, Hansi W. Rd., Beitun District, Taichung City  
TEL:+886-4-2437-6268 FAX:+886-4-2437-6266

For more information, please visit <http://www.idrc.com.tw>  
or contact us E-mail : [sales@idrcms.com.tw](mailto:sales@idrcms.com.tw)

### Beijing China

TEL:+86-10-6498-6421 FAX:+86-10-6498-6411

### Guangdong China

TEL:+86-757-8623-9927 FAX:+86-757-8639-1132

### Suzhou China

TEL:+86-512-6252-9029 FAX:+86-512-6252-7013